



**NORTH BAY ALL WHEEL PARK  
WORKSHOP #1 & ONLINE SURVEY #1  
FEEDBACK SUMMARY REPORT**



**SEPTEMBER 2023**



**NORTH BAY ALL WHEEL PARK  
WORKSHOP #1 & ONLINE SURVEY #1  
FEEDBACK SUMMARY REPORT**

# NORTH BAY ALL WHEEL PARK



## Design Workshop #1

Thurs. Sept. 21 6pm-8pm  
North Bay Museum  
100 Ferguson Street  
North Bay, ON

## Online Survey #1

opens: Sept. 21  
closes: Oct. 5

Learn more about this exciting community project.  
Meet the design team. Complete the survey.  
Show your support and share your ideas.





# NORTH BAY ALL WHEEL PARK WORKSHOP #1 & ONLINE SURVEY #1 FEEDBACK SUMMARY REPORT

**TO:** David Jackowski, P.Eng.  
Project Manager | Special Projects Operations and Infrastructure | City of North Bay

**DATE:** October 17<sup>th</sup>, 2023

**RE:** NORTH BAY ALL WHEEL PARK  
WORKSHOP #1 & DESIGN SURVEY #1  
FEEDBACK SUMMARY REPORT

David,

The following is a summary of the feedback gathered at the In-Person Workshop #1 held in North Bay on September 21, 2023, as well as Online Survey #1 for prepared by New Line Skateparks Inc. and hosted on Google Forms from September 22 to October 3. The In-Person Workshop collected (26) Participant Feedback Forms and the Online Survey collected (311) responses, for a total of (337) total responses! (197) out of (337) total responses (58.46%) were categorized as “Active Park Users”. This first round of Community Outreach shows a very high level of community interest and enthusiasm for the project and provides valuable feedback for the design team to consider in developing the Preliminary Design Directions.

## **PART ONE: DEMOGRAPHIC QUESTIONS**

### **Question 1: Where do you live?**

- **89.0%** in North Bay
- 11.0% outside North Bay

*The majority of responses came from residents living in North Bay (89.0%).*

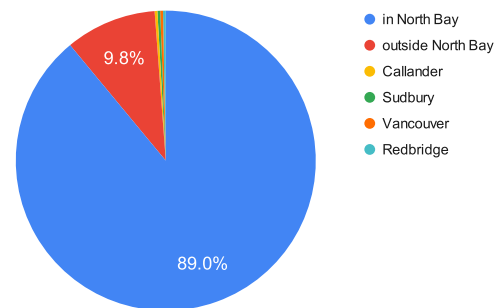

### **Question 2: How old are you?**

- **26.3%** 41-50 years old
- 25.7% 31-40 years old
- 17.0% 21-30 years old
- 19.4% 50+ years old
- 8.4% 11-20 years old

*A wide range of age groups is represented. The largest representation was from participants in the 41-50 year old category.*

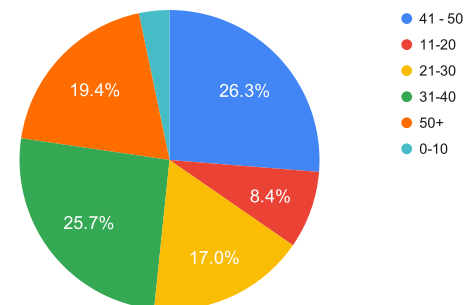



# NORTH BAY ALL WHEEL PARK WORKSHOP #1 & ONLINE SURVEY #1 FEEDBACK SUMMARY REPORT

## PART TWO: PARTICIPATION

**Question 3: I am primarily interested in the project because I am ...**

- 22.6% a skateboarder
- 21.4% a local resident interested in the development of these public spaces
- 18.8% a parent / guardian / spectator of an active park user
- 12.8% a BMX rider

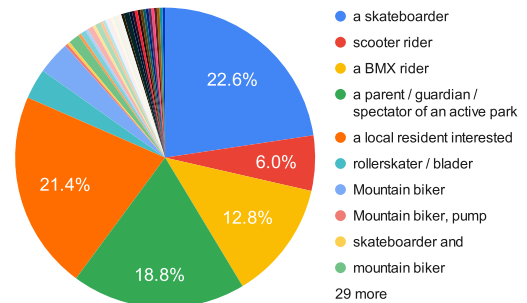

*The majority of responses (22.6%) came from skateboarders. Approx. (58%) of responses can be categorized as "Active Park Users". There was a significant number of responses from the Mountain Bike community; although not our specific target audience, they will be added as a category for 2 Online Survey #2.*

**Question 4: How would you describe your Skateboarding / Riding ability?**

- 41.7% I don't skate or ride
- 28.9% Intermediate
- 22.0% Advanced
- 7.4% Beginner

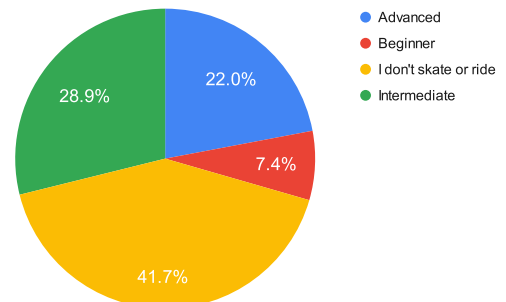

*Our goal is to create a well-rounded design with a broad range of ability levels in mind.*

**Question 5: How often do you skate / ride?**

- 42.3% I don't skate or ride
- 27.1% 3+ days a week
- 22.0% 1-2 times a week
- 8.6% 1-2 times a month

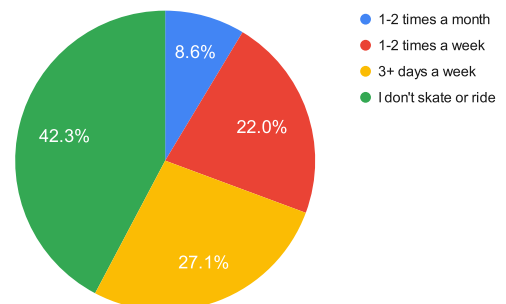

**NOTE:** (197) out of (337) total responses (58.46%) were categorized as "Active Park Users". Only "Active Park Users" were then able to respond to questions re: Preferred Terrain Style and Features.



# NORTH BAY ALL WHEEL PARK WORKSHOP #1 & ONLINE SURVEY #1 FEEDBACK SUMMARY REPORT

## PART THREE: OVERALL TERRAIN STYLE PRIORITIES

**Question 6: What part of the All Wheel Park interests you the most?**

- 50.0% Skatepark
- 50.0% Pump Track

*There is a split of (50.0%) of "Active" survey participants having an interest in the Skatepark vs. the Pump Track.*

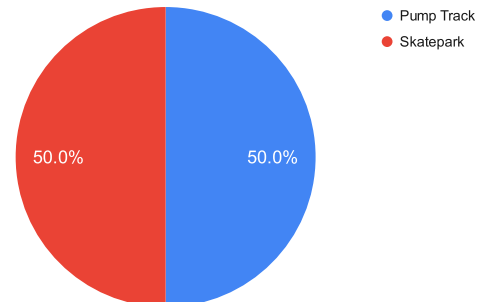

**Question 7: What is your preferred style of Pump Track Terrain?**

- 67.9% Double Track
- 32.1% Single Track

*(67.9%) of "Active" survey participants prefer a Double Track vs. a Single Track.*

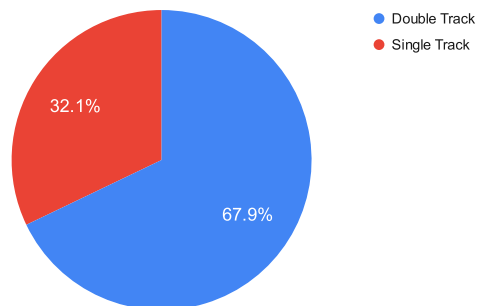

**Question 8: What is your preferred style of Skatepark Terrain?**

- 62.9% Street/Plaza Terrain
- 37.1% Bowl/Transition Terrain

*(62.9%) of "Active" survey participants prefer Street/Plaza style terrain over Bowl/Transition style terrain.*

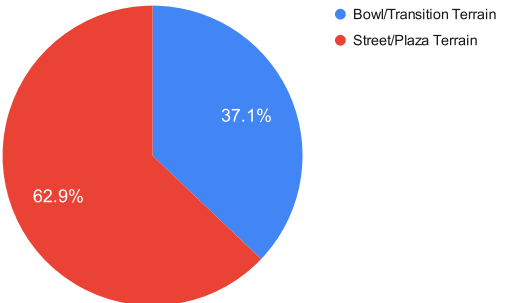

**Question 9: What is your preferred style of Bowl/Transition Terrain?**

- 71.1% Mini Ramp / Open Flow
- 28.9% In-Ground Enclosed Bowls

*(71.1%) of "Active" survey participants prefer Mini Ramp / Open Flow terrain over In-Ground Enclosed Bowls.*

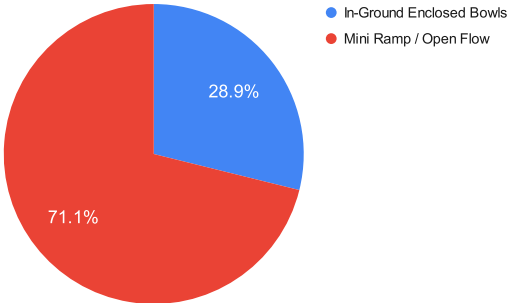

**Question 10: What is your preferred style of Street/Plaza Terrain?**

- 53.6% Flowing Street Terrain (Hips, Funboxes, A-Frames & Stairs - Higher Speed)
- 46.4% Technical Street Terrain (Ledges, Manual Pads, Rails - Lower Speed)

*(53.6%) of "Active" survey participants prefer Technical Street Terrain over Flowing Street Terrain.*

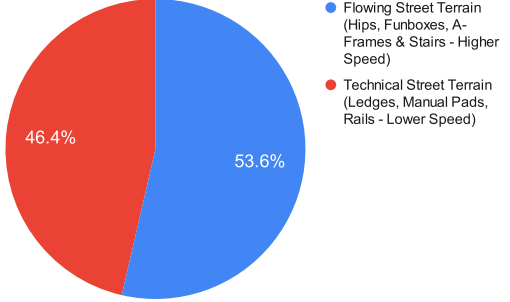



# NORTH BAY ALL WHEEL PARK WORKSHOP #1 & ONLINE SURVEY #1 FEEDBACK SUMMARY REPORT

## PART FOUR: PREFERRED TERRAIN FEATURES

### Question 11: Select your favourite PUMP TRACK feature.

- 41.0% Pocket
- 30.1% Roller
- 28.9% Double Bump/Jump

(41.0%) selected a Pocket as their favourite PT feature.

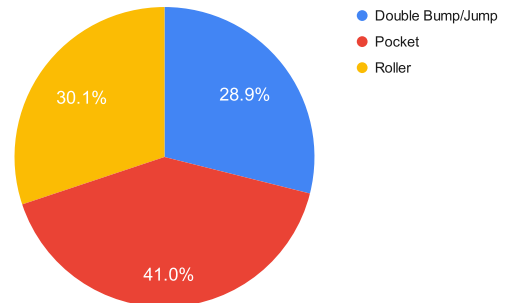

### Question 12: Select your favourite style of ENCLOSED BOWL.

- 55.7% Flow Bowl
- 27.8% Mini Bowl
- 13.4% Pool Bowl

(55.7%) selected a Flow Bowl as their preference.

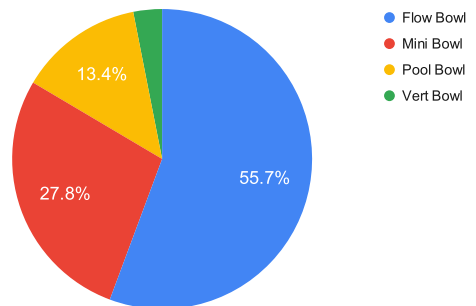

### Question 13: Select your favourite style of MINI RAMP / OPEN FLOW terrain.

- 38.5% Open Flow with coping & extensions
- 32.1% Organic Flow
- 19.2% Mini Ramp

(38.5%) selected a Organic Flow as their favourite.

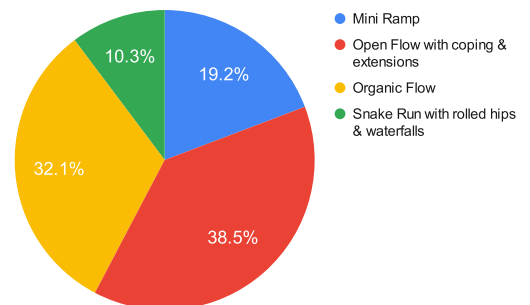

### Question 14: Select your favourite TECHNICAL STREET feature.

- 54.7% Flat Ledges & Rails
- 21.3% Terraced Manual Pads & Ledges
- 14.7% Kicker Gaps
- 9.3% Sidewalk Style Features

(54.7%) selected Flat Ledges & Rails as their favourite.

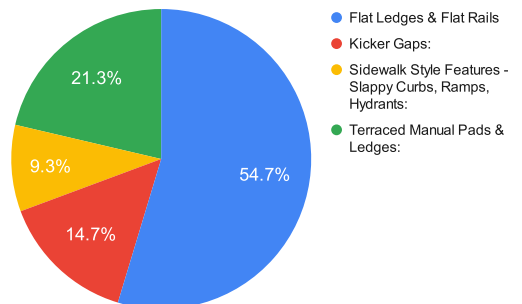

### Question 15: Select your favourite FLOWING STREET feature.

- 50.6% Smaller Stair Set w Rails, Ledges, Banks
- 33.8% Funbox / Pyramid w Ledges, Rails, Drops
- 11.7% A-Frame w Rails & Ledges
- 3.9% Larger Stair Set w Rails, Ledges, Banks

(50.6%) selected Smaller Stair Set w Rails, Ledges, Banks as their favourite.

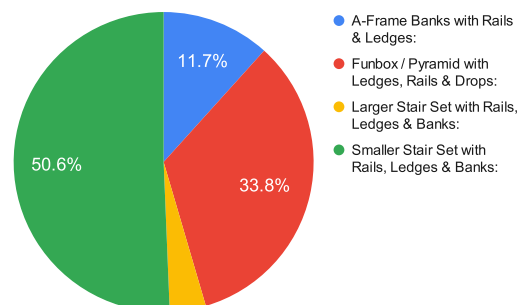



# NORTH BAY ALL WHEEL PARK WORKSHOP #1 & ONLINE SURVEY #1 FEEDBACK SUMMARY REPORT

## Question 16: What's the #1 feature you'd like to see in the North Bay All Wheel Park?

- **High Demand for Pump Tracks:** A significant number of users expressed a strong desire for a Pump Tracks, specifically designed for both shorter and longer (26") wheel bases.
- **Versatility & Multi-Sport Use:** Users are looking for a versatile space that accommodates multiple wheel sports, including biking and skateboarding, with a variety of features.
- **Quality of Materials & Amenities:** There's an emphasis on using smooth finish concrete for the skatepark. Users also suggested amenities like repair stations, water fountains and washrooms.
- **Safety & Community:** Respondents called for shaded areas for parents and spectators, water stations, and security measures to create a safe and inclusive environment.
- **Cultural & Environmental Integration:** Suggestions were made to make the park blend in with the natural surroundings and to pay respects to the indigenous land and community.

## PART FIVE: ADDITIONAL INFORMATION

### Question 17: Beyond the All Wheel Park active terrain, are there any other amenities you'd like to see included? (i.e. seating areas, landscaping, shade, lighting, washrooms, etc.)?

- |         |                 |         |                |
|---------|-----------------|---------|----------------|
| ○ 79.4% | <b>Shade</b>    | ○ 63.1% | Seating Areas  |
| ○ 72.0% | <b>Lighting</b> | ○ 60.6% | Water Fountain |
| ○ 66.8% | Washrooms       | ○ 35.4% | Landscaping    |

### Question 18: Do you have any other questions/comments related to the North Bay All Wheel Park?

- **Pump Tracks & Biking:** Strong desire for a robust Pump Track and bike-friendly features, with some calls for competition-standard design that are tailored for mountain biking and BMX.
- **Safety & Maintenance:** Calls for police presence, security cameras, and ongoing maintenance to ensure the park remains a safe and enjoyable environment.
- **Inclusive & Accessible:** Suggestions for features that cater to various skill levels, age groups and special needs, along with questions about supervision.
- **Community & Culture:** Interest in public art, honouring indigenous land, and additional amenities like bike lockers and water stations.

The feedback summarized here (in addition to a detailed analysis of the Project Scope/Budget and Existing Site Opportunities / Constraints) will be considered in the next phase of Concept Design Development. Please let us know if you have any questions or comments regarding this Survey Summary Report.

Sincerely,

Bill Gurney, OALA, CSLA  
Landscape Architect, Senior Project Manager  
New Line Skateparks Inc.

**APPENDIX (A)**

**TERRAIN PRIORITY DOT BOARDS**



# NORTH BAY ALL WHEEL PARK

TERRAIN PRIORITIES: STREET / PLAZA STYLE TERRAIN

## TECHNICAL STREET TERRAIN



## FLOWING STREET TERRAIN



# NORTH BAY ALL WHEEL PARK

TERRAIN PRIORITIES: BOWL / TRANSITION STYLE TERRAIN

## IN-GROUND ENCLOSED BOWLS

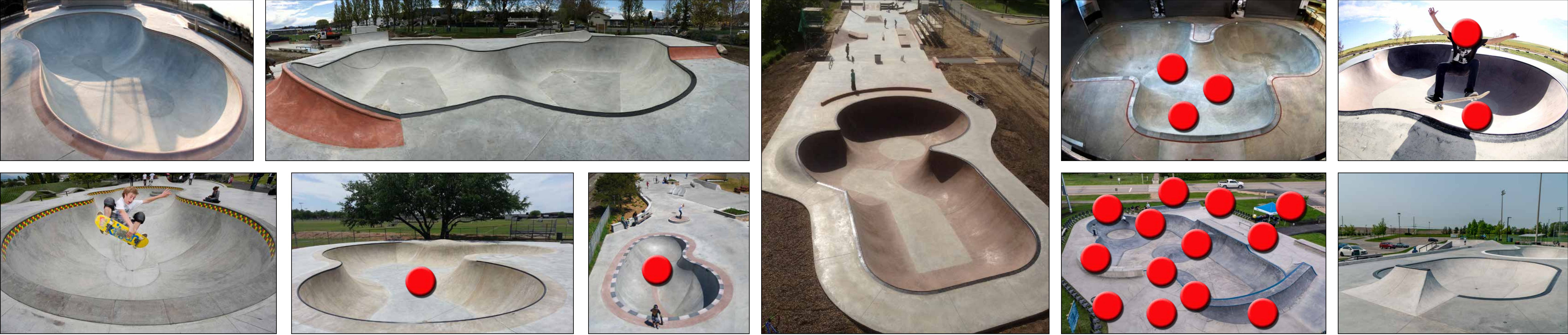

## MINI RAMP / OPEN FLOW

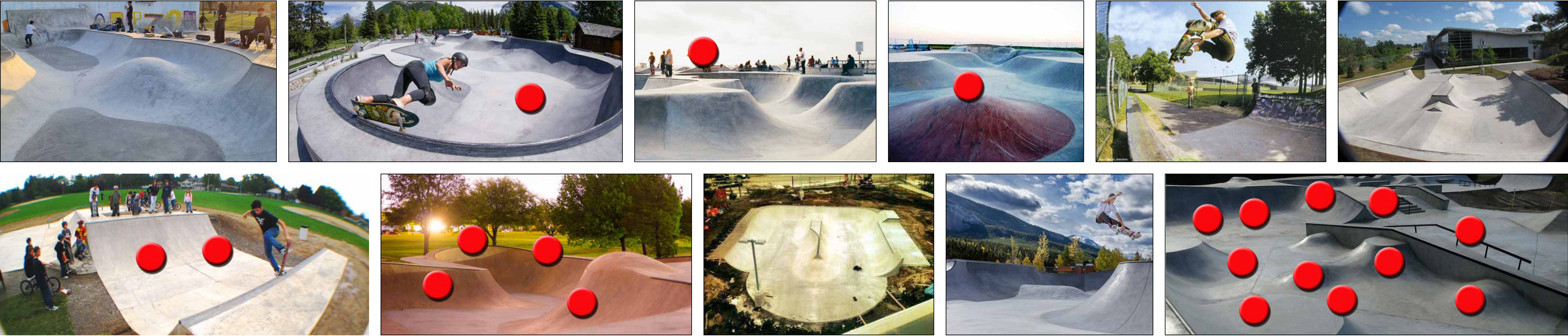

# NORTH BAY ALL WHEEL PARK

## TERRAIN PRIORITIES: PUMP TRACKS



**APPENDIX (B)**

**SCANNED FEEDBACK FORMS**

# NORTH BAY ALL WHEEL PARK

## WORKSHOP FEEDBACK FORM

Name:



Age:

24

Email:

1. What is your primary interest in this project?

- I'm a skateboarder    I'm a BMX rider    I'm a roller skater / blader    I'm a scooter rider  
 I'm a parent / guardian or spectator    Other (please specify) \_\_\_\_\_

2. How would you describe your skateboarding / riding ability?

- Beginner    Intermediate    Advanced    I don't skate or ride

3. How often do you skate / ride?

- 3+ days a week    1-2 times a week    1-2 times a month    I don't skate or ride

4. What part of the All Wheel Park interests you the most?

- Pump Track    Skatepark

5. What is your preferred style of Pump Track Terrain?

- Single Track    Double Track    Other (please specify) potentially no pump track

6. What is your preferred style of Skatepark Terrain?

- Technical Street Terrain    Flowing Street Terrain  
 In-Ground Enclosed Bowls    Mini Ramp / Open Flow  
 Other (please specify) \_\_\_\_\_

7. Beyond the Skatepark & Pump Track facilities themselves, is there anything else you would like to see in the park? (i.e. seating / viewing spaces, landscaping, shade, washrooms, etc.)

Shade and washrooms would set North Bay's park above so many other parks, where the sun isn't much affected and night lights could be added

8. General Comments. (use the adjacent box or back of this sheet if you need more space)

Shadfly's, at night, particularly, at the water front side of the city, get really bad, bottle filling station

\*Please use the space provided above to sketch any ideas for features you want included in the park and/or to provide further comments.



NORTH BAY, ON

September 21, 2023

WWW.NEWLINEKATEPARKS.COM

# NORTH BAY ALL WHEEL PARK

## WORKSHOP FEEDBACK FORM

Name: [Redacted] Age: 29

Email: [Redacted] .com

1. What is your primary interest in this project?

- I'm a skateboarder    I'm a BMX rider    I'm a roller skater / blader    I'm a scooter rider  
 I'm a parent / guardian or spectator    Other (please specify) \_\_\_\_\_

2. How would you describe your skateboarding / riding ability?

- Beginner    Intermediate    Advanced    I don't skate or ride

3. How often do you skate / ride?

- 3+ days a week    1-2 times a week    1-2 times a month    I don't skate or ride  
*Everyday*

4. What part of the All Wheel Park interests you the most?

- Pump Track    Skatepark

5. What is your preferred style of Pump Track Terrain?

- Single Track    Double Track    Other (please specify) \_\_\_\_\_

6. What is your preferred style of Skatepark Terrain?

- Technical Street Terrain    Flowing Street Terrain  
 In-Ground Enclosed Bowls    Mini Ramp / Open Flow  
 Other (please specify) \_\_\_\_\_

7. Beyond the Skatepark & Pump Track facilities themselves, is there anything else you would like to see in the park? (i.e. seating / viewing spaces, landscaping, shade, washrooms, etc.)

Shaded Areas and creative landscaping

8. General Comments. (use the adjacent box or back of this sheet if you need more space)

Pay respects to the indigenous land we are on!

2

Sketches include: a ramp, a pole jam, a ledge step, a loon, a feather, a rail step up, and a hip quarter.

colours to pay respects

- Blue • Green • Yellow
- white

medicine wheel colours

- Black • Yellow • white • Red.

\*Please use the space provided above to sketch any ideas for features you want included in the park and/or to provide further comments.

# NORTH BAY ALL WHEEL PARK

## WORKSHOP FEEDBACK FORM

Name: [REDACTED]

Age: 19

Email: [REDACTED]

1. What is your primary interest in this project?

- I'm a skateboarder  
  I'm a BMX rider  
  I'm a roller skater / blader  
  I'm a scooter rider  
 I'm a parent / guardian or spectator  
  Other (please specify) \_\_\_\_\_

2. How would you describe your skateboarding / riding ability?

- Beginner  
  Intermediate  
  Advanced  
  I don't skate or ride

3. How often do you skate / ride?

- 3+ days a week  
  1-2 times a week  
  1-2 times a month  
  I don't skate or ride

4. What part of the All Wheel Park interests you the most?

- Pump Track  
  Skatepark

5. What is your preferred style of Pump Track Terrain?

- Single Track  
  Double Track  
  Other (please specify) neither (none)

6. What is your preferred style of Skatepark Terrain?

- Technical Street Terrain  
  Flowing Street Terrain  
 In-Ground Enclosed Bowls  
  Mini Ramp / Open Flow  
 Other (please specify) rails, ledges and stairs

7. Beyond the Skatepark & Pump Track facilities themselves, is there anything else you would like to see in the park? (i.e. seating / viewing spaces, landscaping, shade, washrooms, etc.)

Areas with shade and potentially viewing spaces  
Water fountain / bothrooms

8. General Comments. (use the adjacent box or back of this sheet if you need more space)

Shade is a must have!

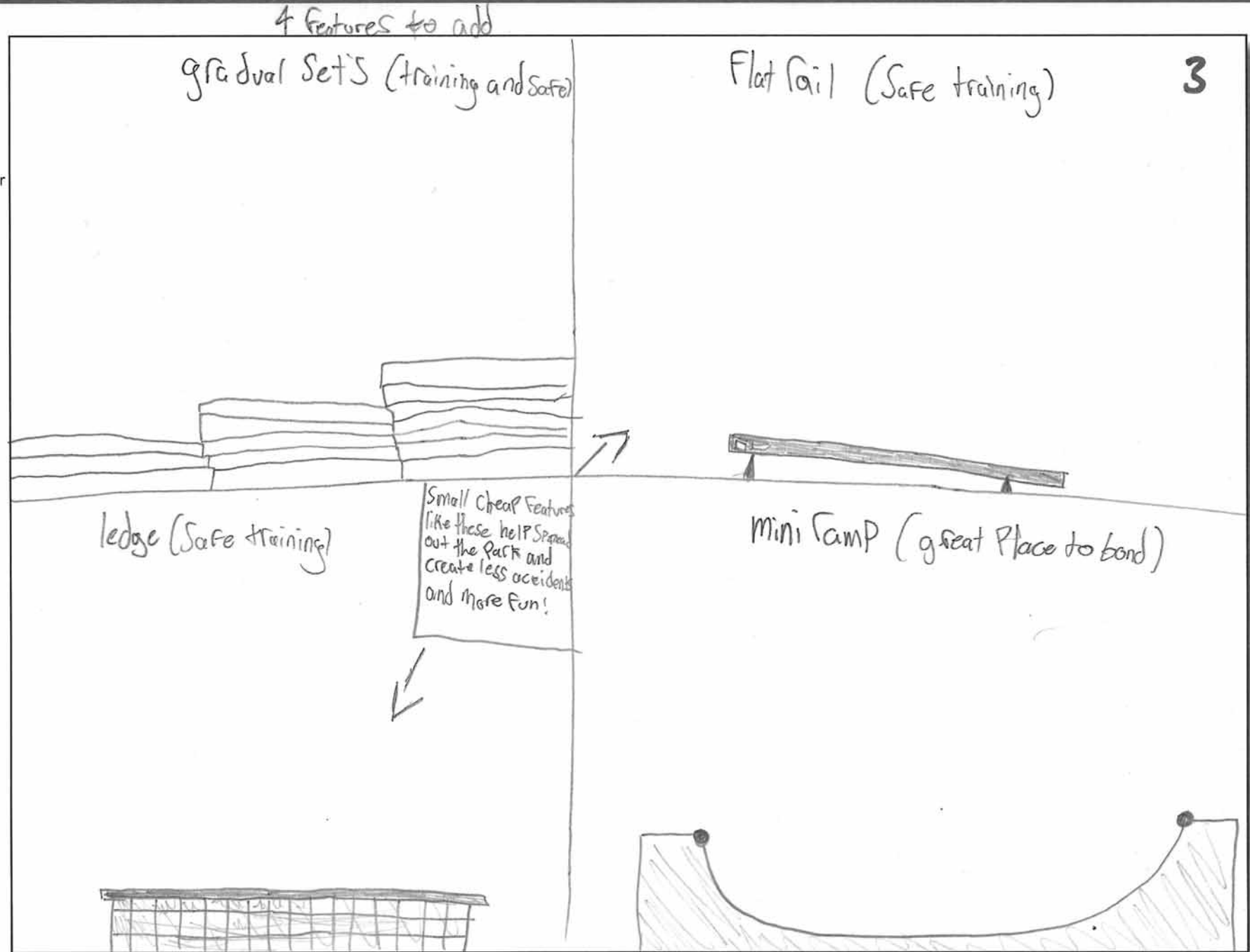

\*Please use the space provided above to sketch any ideas for features you want included in the park and/or to provide further comments.

# NORTH BAY ALL WHEEL PARK

## WORKSHOP FEEDBACK FORM

Name: [Redacted] Age: 19

Email: [Redacted]

1. What is your primary interest in this project?

- I'm a skateboarder  
  I'm a BMX rider  
  I'm a roller skater / blader  
  I'm a scooter rider  
 I'm a parent / guardian or spectator  
  Other (please specify) \_\_\_\_\_

2. How would you describe your skateboarding / riding ability?

- Beginner  
  Intermediate  
  Advanced  
  I don't skate or ride

3. How often do you skate / ride?

- 3+ days a week  
  1-2 times a week  
  1-2 times a month  
  I don't skate or ride

4. What part of the All Wheel Park interests you the most?

- Pump Track  
  Skatepark

5. What is your preferred style of Pump Track Terrain?

- Single Track  
  Double Track  
  Other (please specify) \_\_\_\_\_

6. What is your preferred style of Skatepark Terrain?

- Technical Street Terrain  
  Flowing Street Terrain  
 In-Ground Enclosed Bowls  
  Mini Ramp / Open Flow  
 Other (please specify) Rails Leads Leads

7. Beyond the Skatepark & Pump Track facilities themselves, is there anything else you would like to see in the park? (i.e. seating / viewing spaces, landscaping, shade, washrooms, etc.)

Shade area, Water fountain, Lights, All Night lights  
Seating

8. General Comments. (use the adjacent box or back of this sheet if you need more space)

A Good Flow Would be Great to limit the amount  
of collisions. Round rails are better than square rails

4

LONG Flat rail      Round rails Preferred

↑      ↓

Square      and      round

UP Flat Down rail

Bank to rail

Curve rail Flat

Side by Side

Small Down rail      Small Hubba

Big Down rail      Big Hubba

More on back side →

\*Please use the space provided above to sketch any ideas for features you want included in the park and/or to provide further comments.



Curved Pad + Ledge

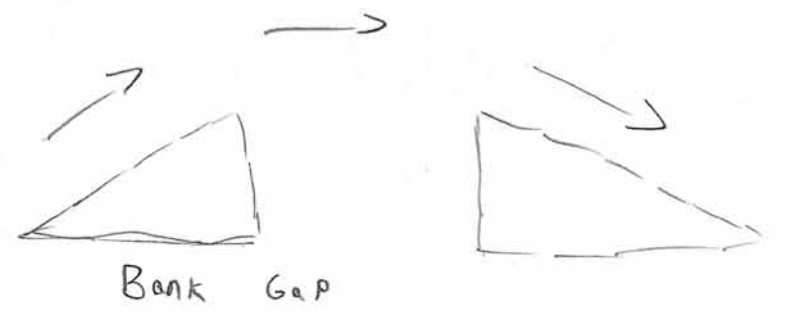
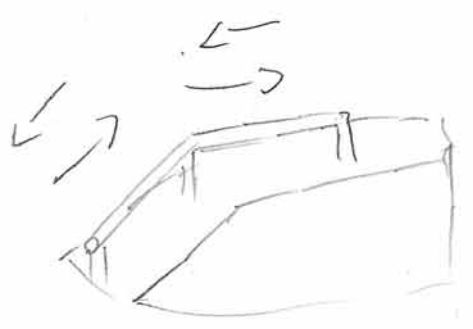

Thank You!!!

Ledge next to rail  
(To jump from ledge to rail)

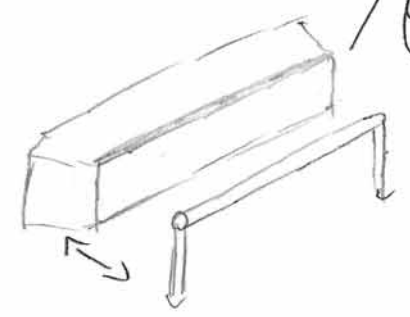

Spine

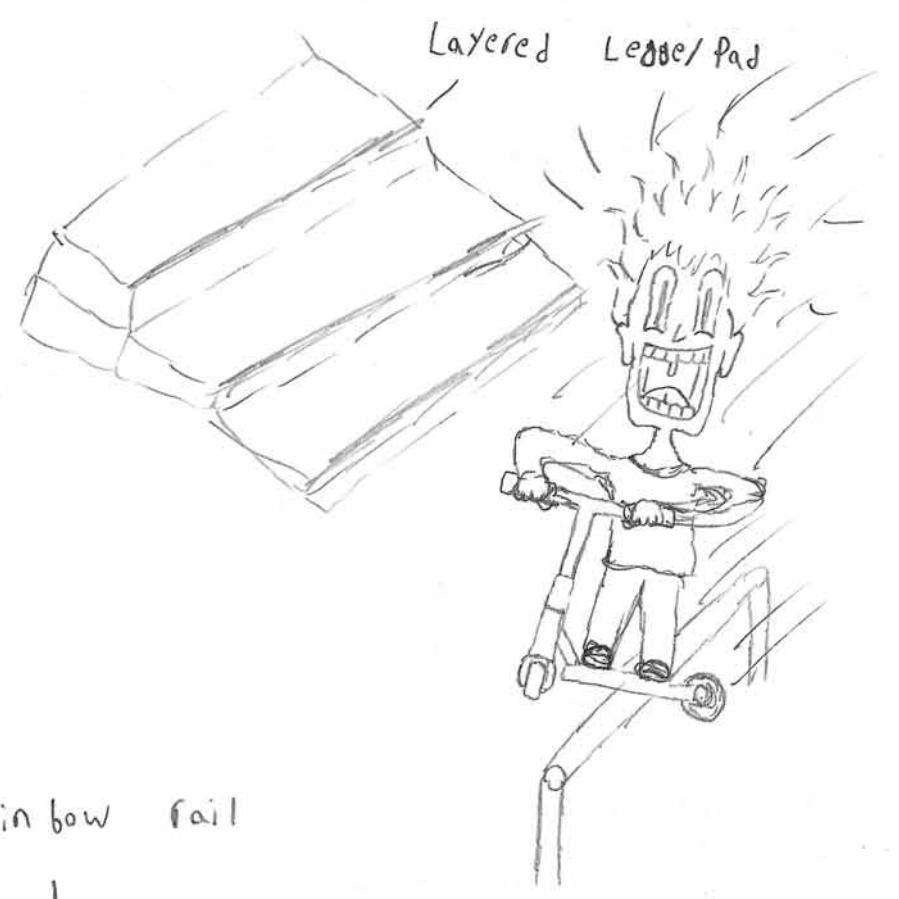
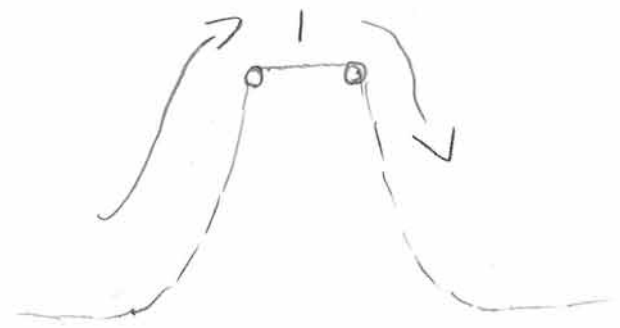

UP Flat down Ledge.



Rail Gap



Rain bow rail

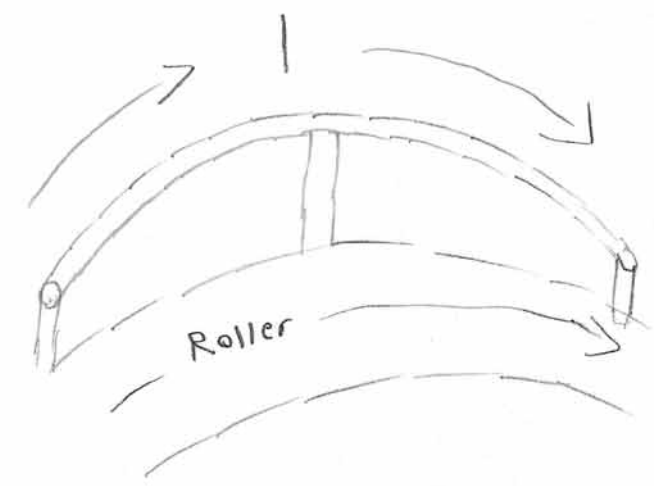

# NORTH BAY ALL WHEEL PARK

## WORKSHOP FEEDBACK FORM

Name: [REDACTED] Age: 26

Email: [REDACTED]

1. What is your primary interest in this project?

- I'm a skateboarder  I'm a BMX rider  I'm a roller skater / blader  I'm a scooter rider  
 I'm a parent / guardian or spectator  Other (please specify) \_\_\_\_\_

2. How would you describe your skateboarding / riding ability?

- Beginner  Intermediate  Advanced  I don't skate or ride

3. How often do you skate / ride?

- 3+ days a week  1-2 times a week  1-2 times a month  I don't skate or ride

4. What part of the All Wheel Park interests you the most?

- Pump Track  Skatepark

5. What is your preferred style of Pump Track Terrain?

- Single Track  Double Track  Other (please specify) \_\_\_\_\_

6. What is your preferred style of Skatepark Terrain?

- Technical Street Terrain  Flowing Street Terrain  
 In-Ground Enclosed Bowls  Mini Ramp / Open Flow  
 Other (please specify) \_\_\_\_\_

7. Beyond the Skatepark & Pump Track facilities themselves, is there anything else you would like to see in the park? (i.e. seating / viewing spaces, landscaping, shade, washrooms, etc.)

PARK TOOL POST WRENCH ALLEN KEY

8. General Comments. (use the adjacent box or back of this sheet if you need more space)



\*Please use the space provided above to sketch any ideas for features you want included in the park and/or to provide further comments.

# NORTH BAY ALL WHEEL PARK

## WORKSHOP FEEDBACK FORM

6

Age: 5, 7, 7, 30

1. What is your primary interest in this project?

- I'm a skateboarder    I'm a BMX rider    I'm a roller skater / blader    I'm a scooter rider  
 I'm a parent / guardian or spectator    Other (please specify) \_\_\_\_\_

2. How would you describe your skateboarding / riding ability?

- Beginner    Intermediate    Advanced    I don't skate or ride

3. How often do you skate / ride?

- 3+ days a week    1-2 times a week    1-2 times a month    I don't skate or ride

4. What part of the All Wheel Park interests you the most?

- Pump Track    Skatepark

5. What is your preferred style of Pump Track Terrain?

- Single Track    Double Track    Other (please specify) i don't know

6. What is your preferred style of Skatepark Terrain?

- Technical Street Terrain    Flowing Street Terrain  
 In-Ground Enclosed Bowls    Mini Ramp / Open Flow  
 Other (please specify) \_\_\_\_\_

7. Beyond the Skatepark & Pump Track facilities themselves, is there anything else you would like to see in the park? (i.e. seating / viewing spaces, landscaping, shade, washrooms, etc.)

rock climbing wall behind big ramps. not ladders

butterfly mural or wings to stand in front of

8. General Comments. (use the adjacent box or back of this sheet if you need more space)

on the corner of stanley and memorial drive is a plaque of names that use the trans Canada trail. Maybe a small plaque or mural list of all the community members attending to help make history.

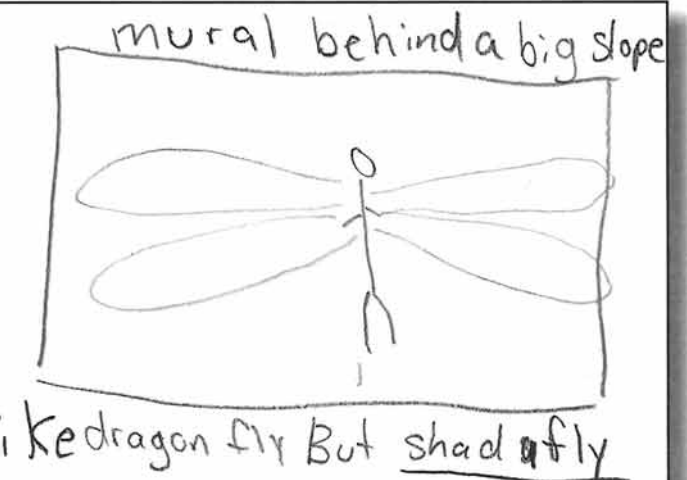
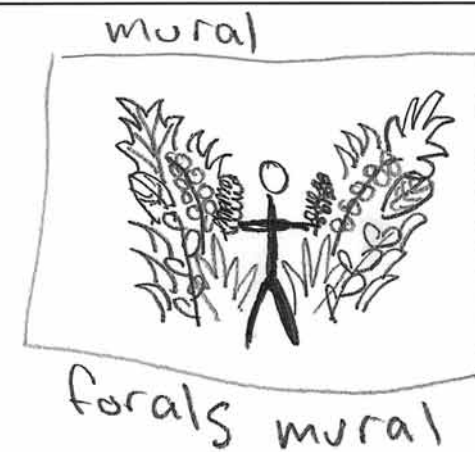

North bay famous for shad flys

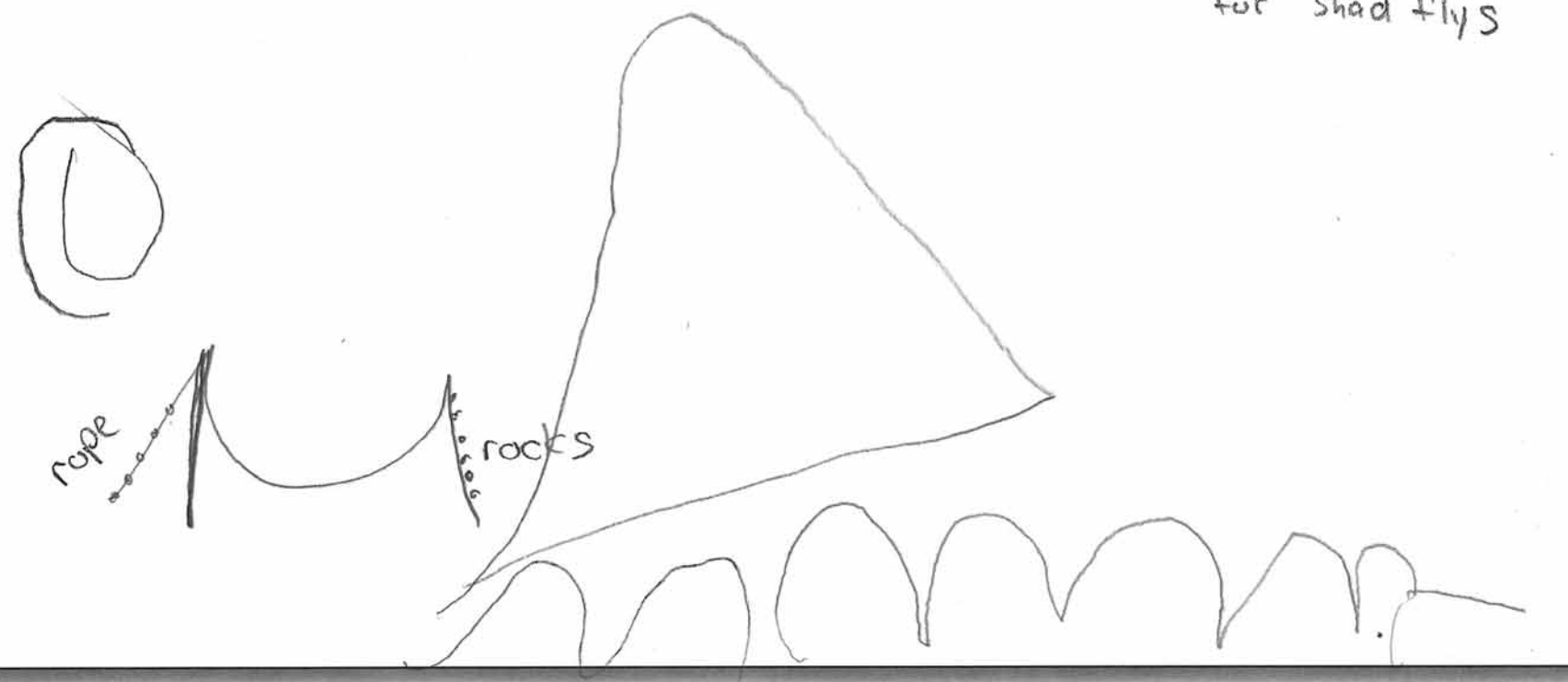

\*Please use the space provided above to sketch any ideas for features you want included in the park and/or to provide further comments.



**NORTH BAY, ON**

September 21, 2023

WWW.NEWLINESSKATEPARKS.COM

# NORTH BAY ALL WHEEL PARK

## WORKSHOP FEEDBACK FORM

7

Name: [Redacted] Age: 26

Email: [Redacted]

1. What is your primary interest in this project?

- I'm a skateboarder  
  I'm a BMX rider  
  I'm a roller skater / blader  
  I'm a scooter rider  
 I'm a parent / guardian or spectator  
  Other (please specify) \_\_\_\_\_

2. How would you describe your skateboarding / riding ability?

- Beginner  
  Intermediate  
 Advanced  
 I don't skate or ride

3. How often do you skate / ride?

- 3+ days a week  
 1-2 times a week  
 1-2 times a month  
 I don't skate or ride

4. What part of the All Wheel Park interests you the most?

- Pump Track  
 Skatepark

5. What is your preferred style of Pump Track Terrain?

- Single Track  
 Double Track  
 Other (please specify) Small single track

6. What is your preferred style of Skatepark Terrain?

- Technical Street Terrain  
 Flowing Street Terrain  
 In-Ground Enclosed Bowls  
 Mini Ramp / Open Flow  
 Other (please specify) We are so passionate, we want it all

7. Beyond the Skatepark & Pump Track facilities themselves, is there anything else you would like to see in the park? (i.e. seating / viewing spaces, landscaping, shade, washrooms, etc.)

Somewhere to fill water bottles  
Some sun shade, & some decent picnic tables

8. General Comments. (use the adjacent box, or back of this sheet if you need more space)

Y'all are super blessed! Thank you so much

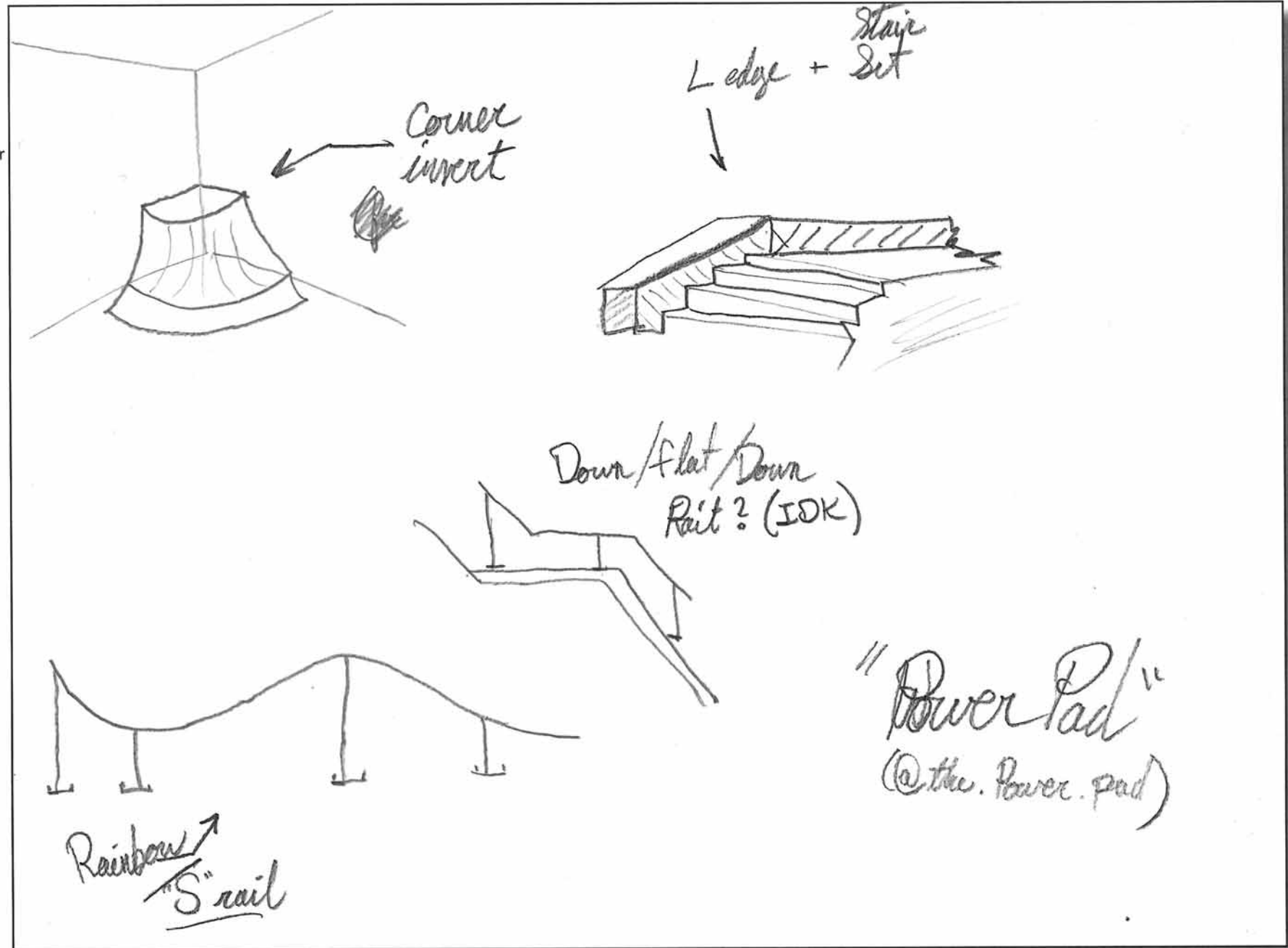

\*Please use the space provided above to sketch any ideas for features you want included in the park and/or to provide further comments.

# NORTH BAY ALL WHEEL PARK

## WORKSHOP FEEDBACK FORM

8

Name: [REDACTED]

Age: 17

Email: [REDACTED]

1. What is your primary interest in this project?

- I'm a skateboarder    I'm a BMX rider    I'm a roller skater / blader    I'm a scooter rider  
 I'm a parent / guardian or spectator    Other (please specify) \_\_\_\_\_

2. How would you describe your skateboarding / riding ability?

- Beginner    Intermediate    Advanced    I don't skate or ride

3. How often do you skate / ride?

- 3+ days a week    1-2 times a week    1-2 times a month    I don't skate or ride

4. What part of the All Wheel Park interests you the most?

- Pump Track    Skatepark

5. What is your preferred style of Pump Track Terrain?

- Single Track    Double Track    Other (please specify) \_\_\_\_\_

6. What is your preferred style of Skatepark Terrain?

- Technical Street Terrain    Flowing Street Terrain  
 In-Ground Enclosed Bowls    Mini Ramp / Open Flow  
 Other (please specify) \_\_\_\_\_

7. Beyond the Skatepark & Pump Track facilities themselves, is there anything else you would like to see in the park? (i.e. seating / viewing spaces, landscaping, shade, washrooms, etc.)

lights at night, shaded area, drinking station, bathrooms,

8. General Comments. (use the adjacent box or back of this sheet if you need more space)

We need fences or something to fix & keep out the homeless to make it a safe environment for everyone.

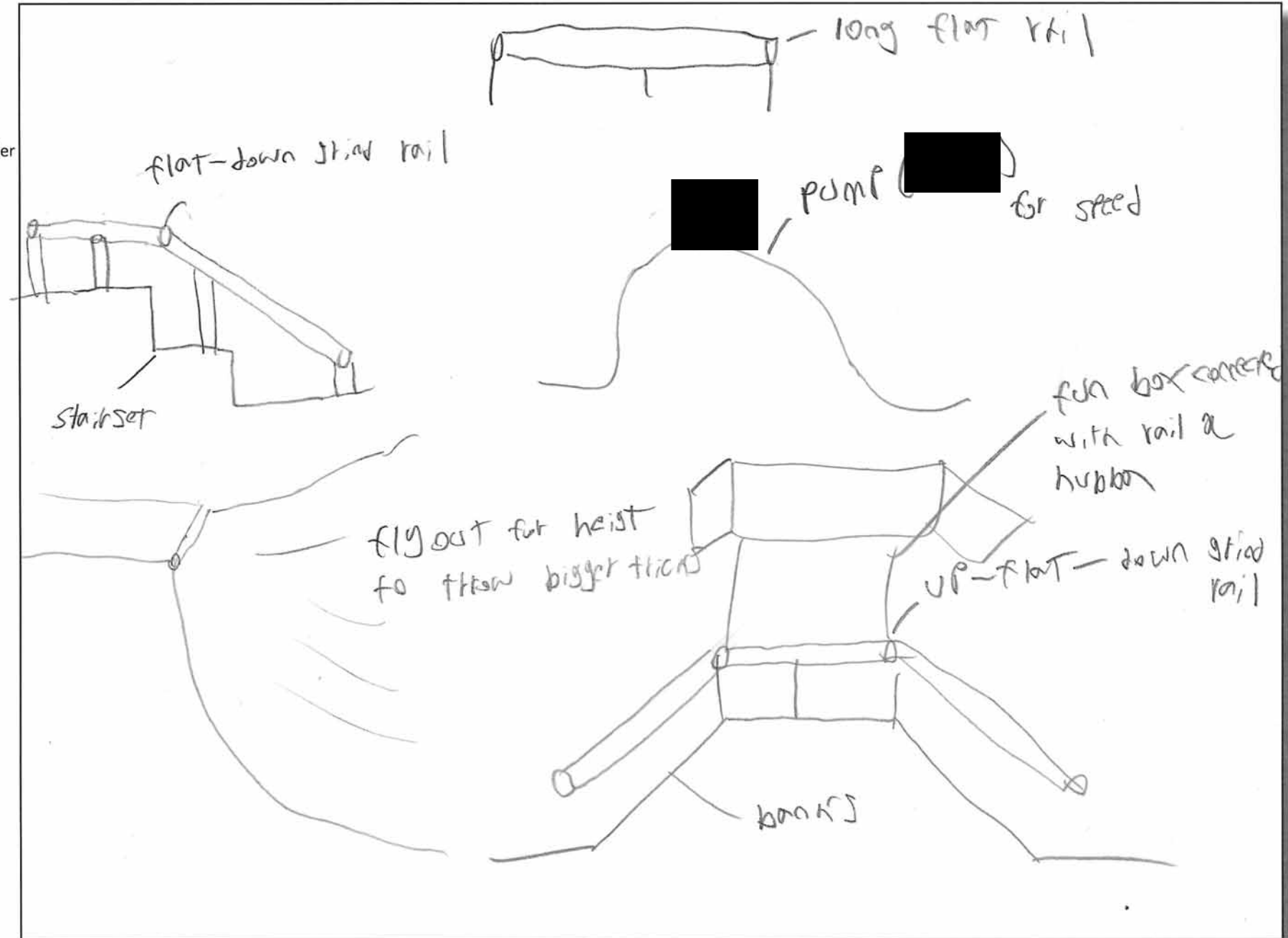

\*Please use the space provided above to sketch any ideas for features you want included in the park and/or to provide further comments.

# NORTH BAY ALL WHEEL PARK

9

## WORKSHOP FEEDBACK FORM

Name

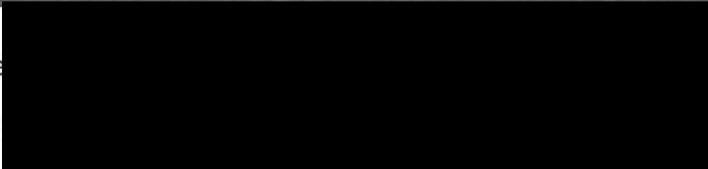

Age:

26

Email

1. What is your primary interest in this project?

- I'm a skateboarder    I'm a BMX rider    I'm a roller skater / blader    I'm a scooter rider  
 I'm a parent / guardian or spectator    Other (please specify) \_\_\_\_\_

2. How would you describe your skateboarding / riding ability?

- Beginner    Intermediate    Advanced    I don't skate or ride

3. How often do you skate / ride?

- 3+ days a week    1-2 times a week    1-2 times a month    I don't skate or ride

4. What part of the All Wheel Park interests you the most?

- Pump Track    Skatepark

5. What is your preferred style of Pump Track Terrain?

- Single Track    Double Track    Other (please specify) Street terrain/flow

6. What is your preferred style of Skatepark Terrain?

- Technical Street Terrain    Flowing Street Terrain  
 In-Ground Enclosed Bowls    Mini Ramp / Open Flow  
 Other (please specify) \_\_\_\_\_

7. Beyond the Skatepark & Pump Track facilities themselves, is there anything else you would like to see in the park? (i.e. seating / viewing spaces, landscaping, shade, washrooms, etc.)

~~An area with some flat ground~~  
- Rain-coverage -

8. General Comments. (use the adjacent box or back of this sheet if you need more space)

Had respect to Inline on bringing  
some democracy to the community

\*Insert extremely Shreddable features here\*

\*Please use the space provided above to sketch any ideas for features you want included in the park and/or to provide further comments.



NORTH BAY, ON

September 21, 2023

WWW.NEWLINESKATEPARKS.COM

# NORTH BAY ALL WHEEL PARK

10

Name: [redacted] Age: 28

Email: [redacted]

1. What is your primary interest in this project?

- I'm a skateboarder    I'm a BMX rider    I'm a roller skater / blader    I'm a scooter rider  
 I'm a parent / guardian or spectator    Other (please specify) \_\_\_\_\_

2. How would you describe your skateboarding / riding ability?

- Beginner    Intermediate    Advanced    I don't skate or ride

3. How often do you skate / ride?

- 3+ days a week    1-2 times a week    1-2 times a month    I don't skate or ride

4. What part of the All Wheel Park interests you the most?

- Pump Track    Skatepark

5. What is your preferred style of Pump Track Terrain?

- Single Track    Double Track    Other (please specify) \_\_\_\_\_

6. What is your preferred style of Skatepark Terrain?

- Technical Street Terrain    Flowing Street Terrain  
 In-Ground Enclosed Bowls    Mini Ramp / Open Flow  
 Other (please specify) Mellow quarter to pit on.

7. Beyond the Skatepark & Pump Track facilities themselves, is there anything else you would like to see in the park? (i.e. seating / viewing spaces, landscaping, shade, washrooms, etc.)

All night lights / shade / washrooms  
water filling strategy / transfer from pump track  
to skate park / good floor.

8. General Comments. (use the adjacent box or back of this sheet if you need more space)

Thanks you!

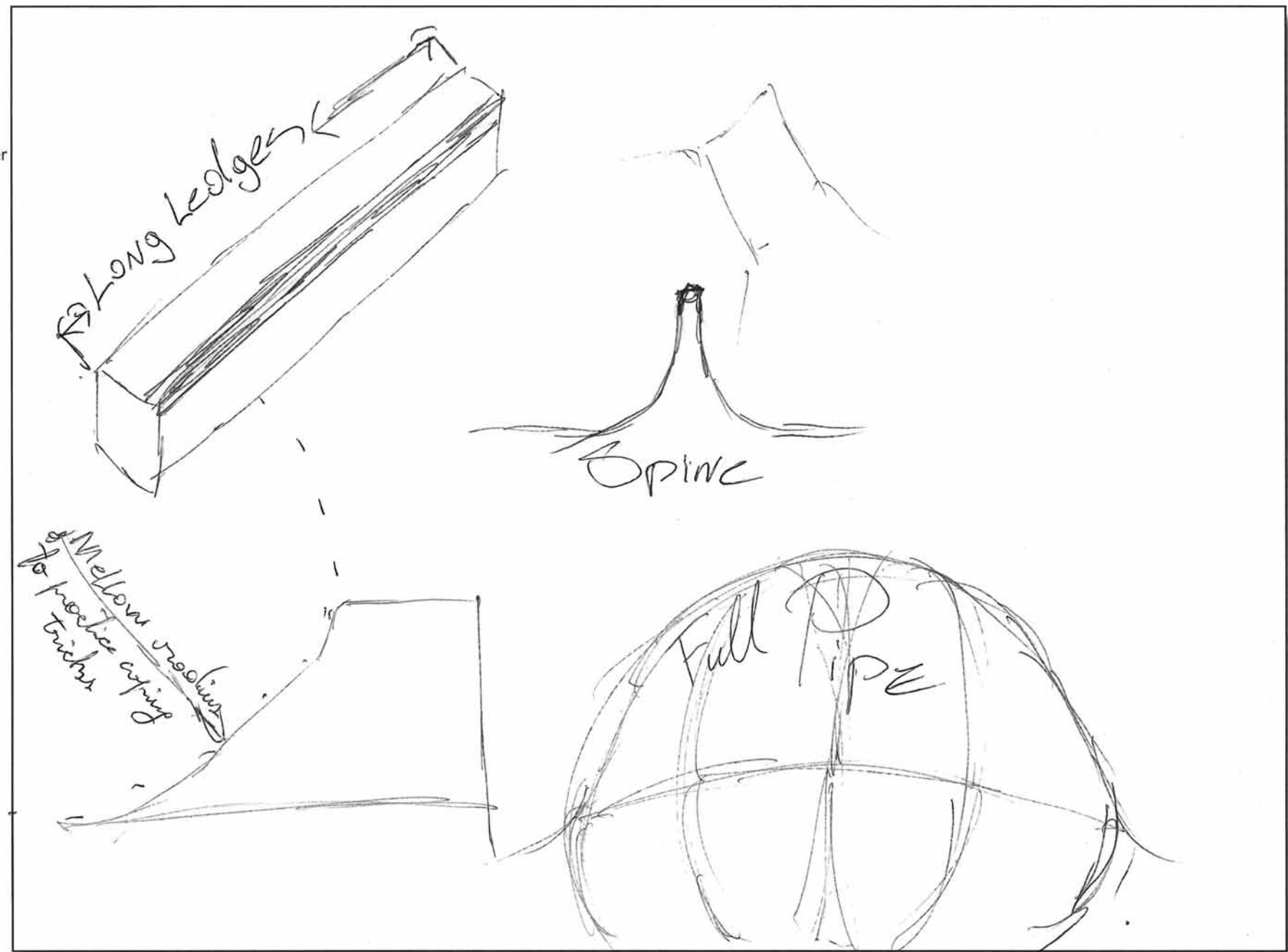

\*Please use the space provided above to sketch any ideas for features you want included in the park and/or to provide further comments.



NORTH BAY, ON

September 21, 2023

WWW.NEWLINESKATEPARKS.COM

# NORTH BAY ALL WHEEL PARK

## WORKSHOP FEEDBACK FORM

Name: [REDACTED]

Age: 27

Email: \_\_\_\_\_

1. What is your primary interest in this project?

- I'm a skateboarder   
  I'm a BMX rider   
  I'm a roller skater / blader   
  I'm a scooter rider  
 I'm a parent / guardian or spectator   
  Other (please specify) \_\_\_\_\_

2. How would you describe your skateboarding / riding ability?

- Beginner   
  Intermediate   
  Advanced   
  I don't skate or ride

3. How often do you skate / ride?

- 3+ days a week   
  1-2 times a week   
  1-2 times a month   
  I don't skate or ride

4. What part of the All Wheel Park interests you the most?

- Pump Track   
  Skatepark

5. What is your preferred style of Pump Track Terrain?

- Single Track   
  Double Track   
  Other (please specify) \_\_\_\_\_

6. What is your preferred style of Skatepark Terrain?

- Technical Street Terrain   
  Flowing Street Terrain  
 In-Ground Enclosed Bowls   
  Mini Ramp / Open Flow  
 Other (please specify) \_\_\_\_\_

7. Beyond the Skatepark & Pump Track facilities themselves, is there anything else you would like to see in the park? (i.e. seating / viewing spaces, landscaping, shade, washrooms, etc.)

I like to see different art street sections,  
fish bridges Skate Park in Toronto is a good example

8. General Comments. (use the adjacent box or back of this sheet if you need more space)

a big enough concrete park for bmxers  
to ride nothing too small big long ledges

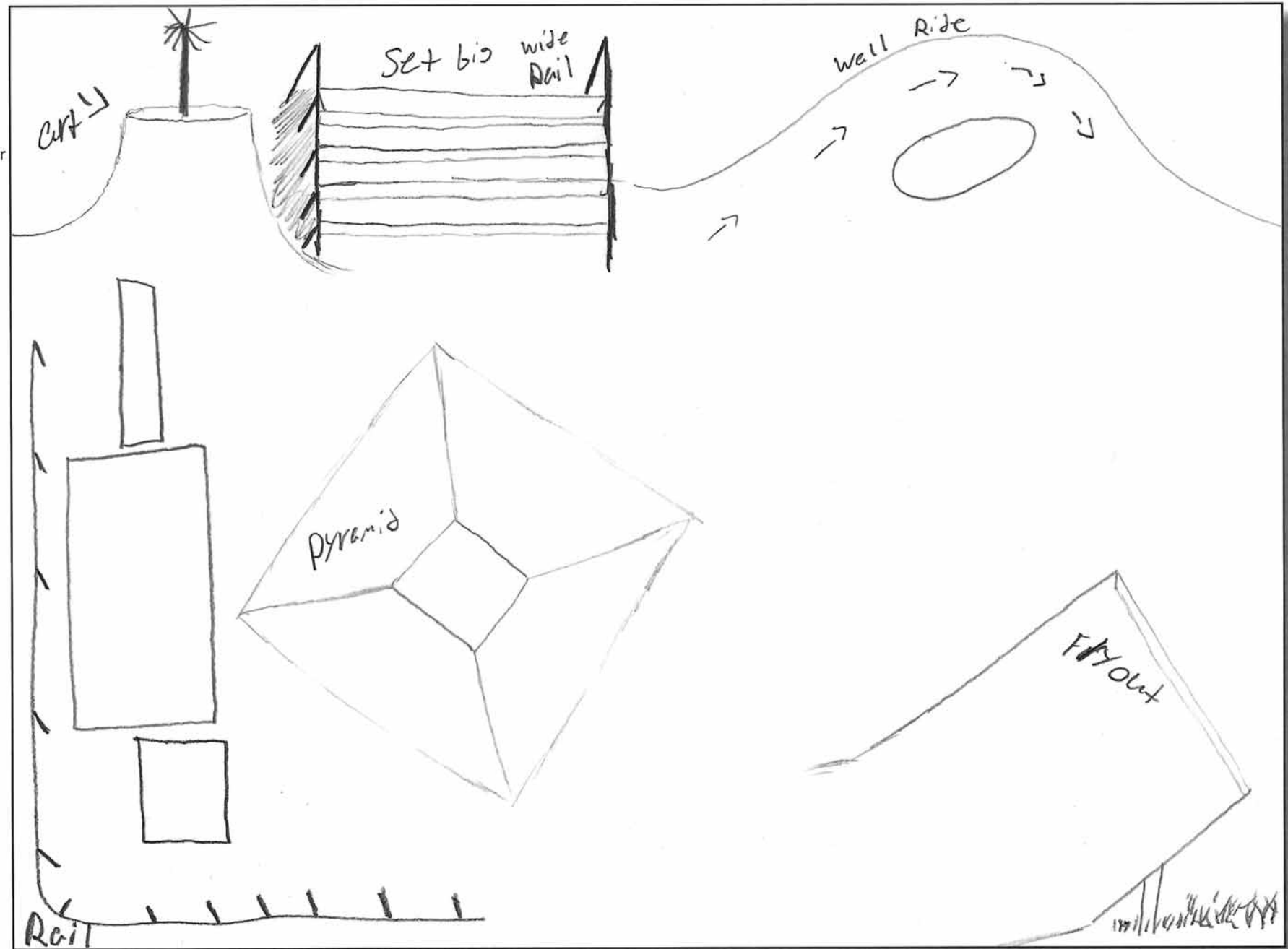

\*Please use the space provided above to sketch any ideas for features you want included in the park and/or to provide further comments.



# NORTH BAY ALL WHEEL PARK

## WORKSHOP FEEDBACK FORM

12

Name: [REDACTED] Age: 47

Email: [REDACTED] .com

1. What is your primary interest in this project?

- I'm a skateboarder    I'm a BMX rider    I'm a roller skater / blader    I'm a scooter rider  
 I'm a parent / guardian or spectator    Other (please specify) FOR THE CITY!!

2. How would you describe your skateboarding / riding ability?

- Beginner    Intermediate    Advanced    I don't skate or ride

3. How often do you skate / ride?

- 3+ days a week    1-2 times a week    1-2 times a month    I don't skate or ride

4. What part of the All Wheel Park interests you the most?

- Pump Track    Skatepark

5. What is your preferred style of Pump Track Terrain?

- Single Track    Double Track    Other (please specify) WITH GOOD FLOW

6. What is your preferred style of Skatepark Terrain?

- Technical Street Terrain    Flowing Street Terrain  
 In-Ground Enclosed Bowls    Mini Ramp / Open Flow  
 Other (please specify) \_\_\_\_\_

7. Beyond the Skatepark & Pump Track facilities themselves, is there anything else you would like to see in the park? (i.e. seating / viewing spaces, landscaping, shade, washrooms, etc.)

SHADE

8. General Comments. (use the adjacent box or back of this sheet if you need more space)

~~MY MAIN HOPE IS THAT THE PARK DESIGN WILL BE CONSIDERED THE BEST IN NORTHERN ONTARIO, SO THAT ALL OF ONTARIO WILL WANT TO MAKE A TRIP.~~  
MY MAIN HOPE IS THAT THE PARK DESIGN WILL BE CONSIDERED THE BEST IN NORTHERN ONTARIO, SO THAT ALL OF ONTARIO WILL WANT TO MAKE A TRIP.

\*Please use the space provided above to sketch any ideas for features you want included in the park and/or to provide further comments.



NORTH BAY, ON

September 21, 2023

WWW.NEWLINESKATEPARKS.COM

# NORTH BAY ALL WHEEL PARK

## WORKSHOP FEEDBACK FORM

Name: [REDACTED] Age: 25

Email: [REDACTED]

1. What is your primary interest in this project?

- I'm a skateboarder   
  I'm a BMX rider   
  I'm a roller skater / blader   
  I'm a scooter rider  
 I'm a parent / guardian or spectator   
  Other (please specify) \_\_\_\_\_

2. How would you describe your skateboarding / riding ability?

- Beginner   
  Intermediate   
  Advanced   
  I don't skate or ride

3. How often do you skate / ride?

- 3+ days a week   
  1-2 times a week   
  1-2 times a month   
  I don't skate or ride

4. What part of the All Wheel Park interests you the most?

- Pump Track   
  Skatepark

5. What is your preferred style of Pump Track Terrain?

- Single Track   
  Double Track   
  Other (please specify) \_\_\_\_\_

6. What is your preferred style of Skatepark Terrain?

- Technical Street Terrain   
  Flowing Street Terrain  
 In-Ground Enclosed Bowls   
  Mini Ramp / Open Flow  
 Other (please specify) Open Flow Street X Ramp ends

7. Beyond the Skatepark & Pump Track facilities themselves, is there anything else you would like to see in the park? (i.e. seating / viewing spaces, landscaping, shade, washrooms, etc.)

Any Seating should be near a spot you would host a game of skate. Place area out of the flow  
Access to outlets would be sick

8. General Comments. (use the adjacent box or back of this sheet if you need more space)

Child sized features that double as good practice ledges/ramps away from main area. Keep the kids in mind but out of the way.

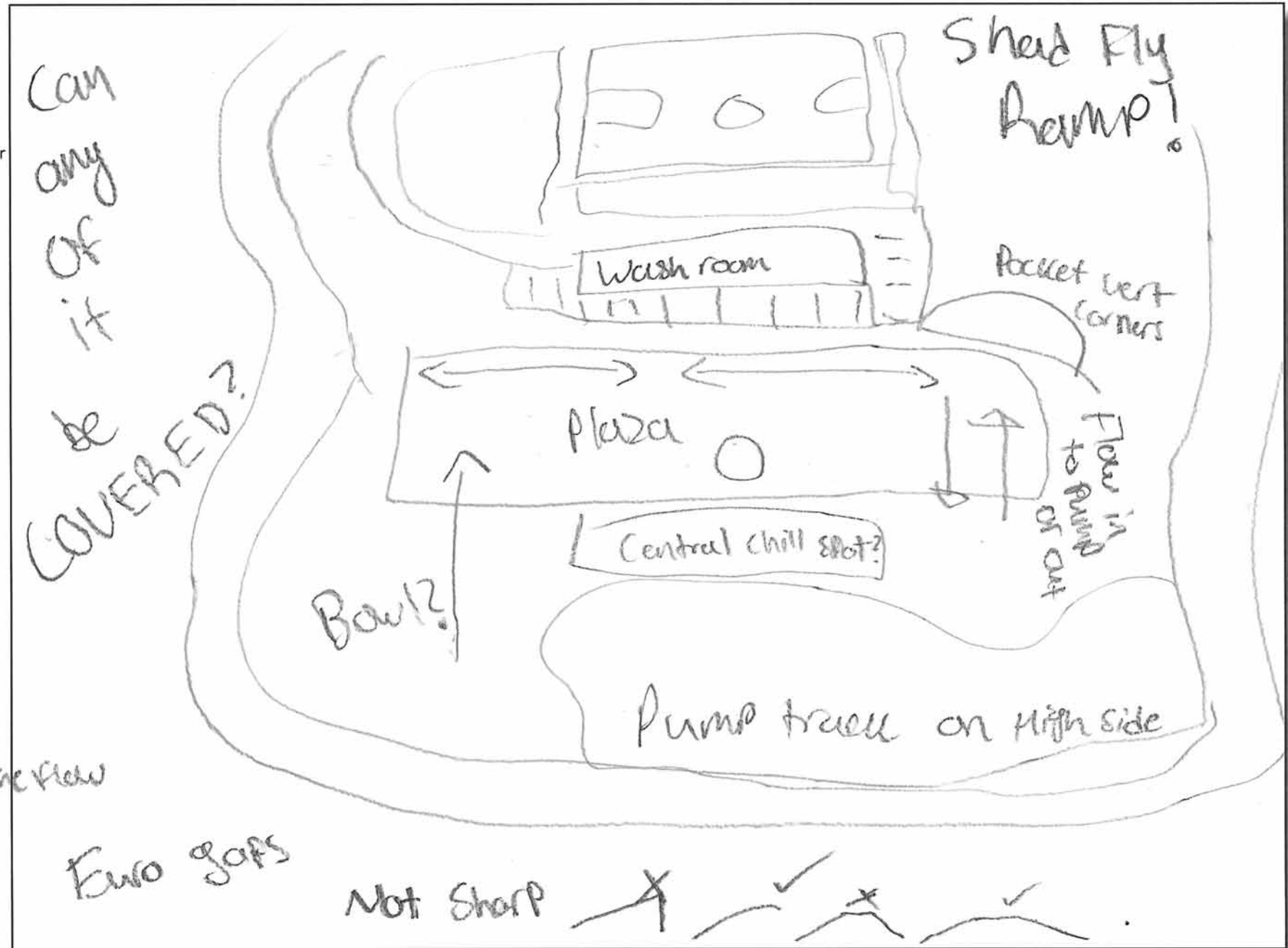

\*Please use the space provided above to sketch any ideas for features you want included in the park and/or to provide further comments.

# NORTH BAY ALL WHEEL PARK

## WORKSHOP FEEDBACK FORM

Name: [redacted] Age: 18

Email: [redacted]

1. What is your primary interest in this project?

- I'm a skateboarder
- I'm a BMX rider
- I'm a roller skater / blader
- I'm a scooter rider
- I'm a parent / guardian or spectator
- Other (please specify) \_\_\_\_\_

2. How would you describe your skateboarding / riding ability?

- Beginner
- Intermediate
- Advanced
- I don't skate or ride

3. How often do you skate / ride?

- 3+ days a week
- 1-2 times a week
- 1-2 times a month
- I don't skate or ride

4. What part of the All Wheel Park interests you the most?

- Pump Track
- Skatepark

5. What is your preferred style of Pump Track Terrain?

- Single Track
- Double Track
- Other (please specify) \_\_\_\_\_

6. What is your preferred style of Skatepark Terrain?

- Technical Street Terrain
- Flowing Street Terrain
- In-Ground Enclosed Bowls
- Mini Ramp / Open Flow
- Other (please specify) down rails

7. Beyond the Skatepark & Pump Track facilities themselves, is there anything else you would like to see in the park? (i.e. seating / viewing spaces, landscaping, shade, washrooms, etc.)

seating, its annoying when people sit on the benches

8. General Comments. (use the adjacent box or back of this sheet if you need more space)

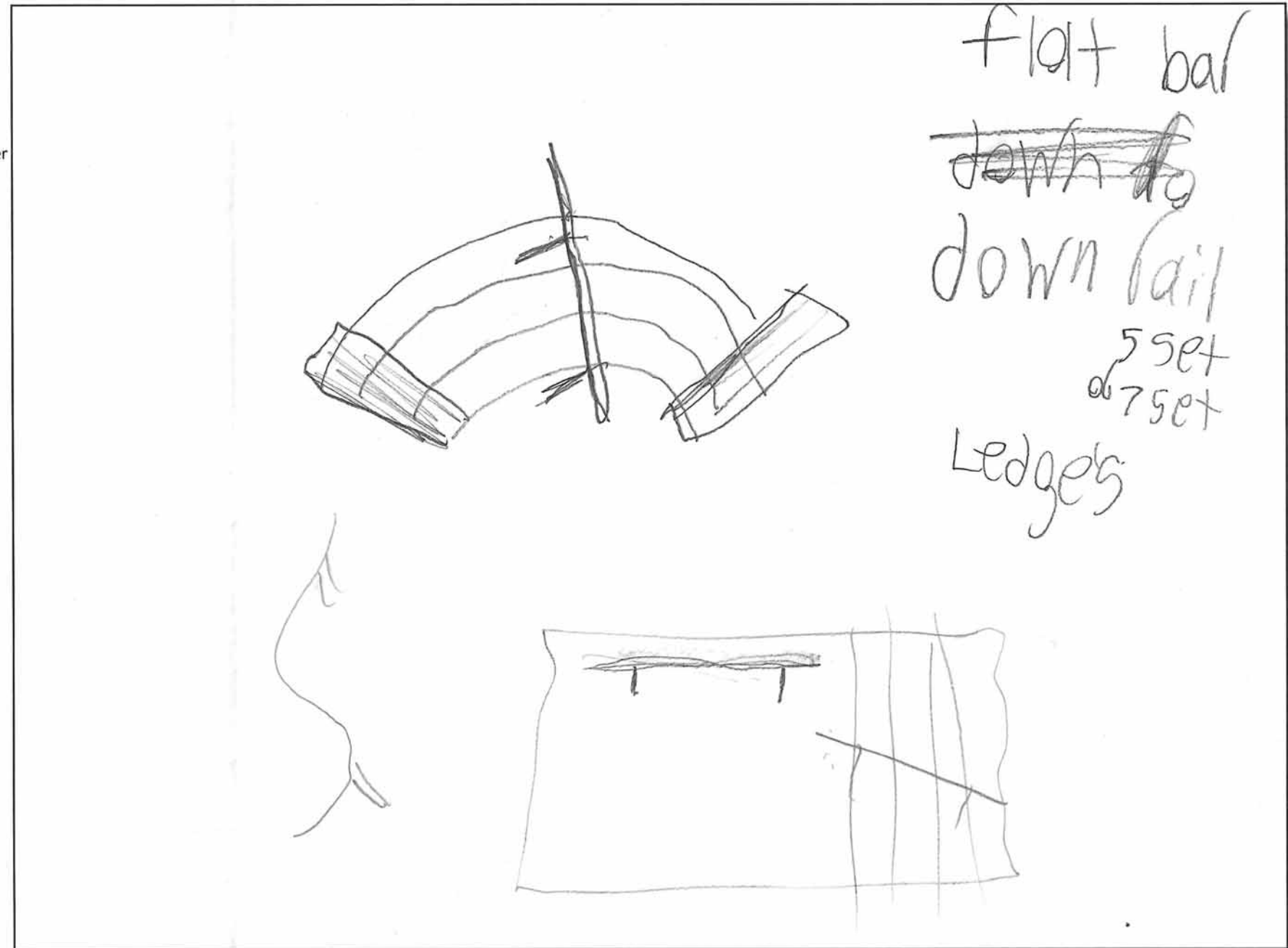

\*Please use the space provided above to sketch any ideas for features you want included in the park and/or to provide further comments.



NORTH BAY, ON

September 21, 2023

WWW.NEWLINESKATEPARKS.COM

# NORTH BAY ALL WHEEL PARK

## WORKSHOP FEEDBACK FORM

15

Name: [REDACTED]

Age: 9

Email: \_\_\_\_\_

1. What is your primary interest in this project?

- I'm a skateboarder    I'm a BMX rider    I'm a roller skater / blader    I'm a scooter rider  
 I'm a parent / guardian or spectator    Other (please specify) \_\_\_\_\_

2. How would you describe your skateboarding / riding ability?

- Beginner    Intermediate    Advanced    I don't skate or ride

3. How often do you skate / ride?

- 3+ days a week    1-2 times a week    1-2 times a month    I don't skate or ride

4. What part of the All Wheel Park interests you the most?

- Pump Track    Skatepark

5. What is your preferred style of Pump Track Terrain?

- Single Track    Double Track    Other (please specify) \_\_\_\_\_

6. What is your preferred style of Skatepark Terrain?

- Technical Street Terrain    Flowing Street Terrain  
 In-Ground Enclosed Bowls    Mini Ramp / Open Flow  
 Other (please specify) \_\_\_\_\_

7. Beyond the Skatepark & Pump Track facilities themselves, is there anything else you would like to see in the park? (i.e. seating / viewing spaces, landscaping, shade, washrooms, etc.)

\_\_\_\_\_  
\_\_\_\_\_  
\_\_\_\_\_

8. General Comments. (use the adjacent box or back of this sheet if you need more space)

\_\_\_\_\_  
\_\_\_\_\_  
\_\_\_\_\_

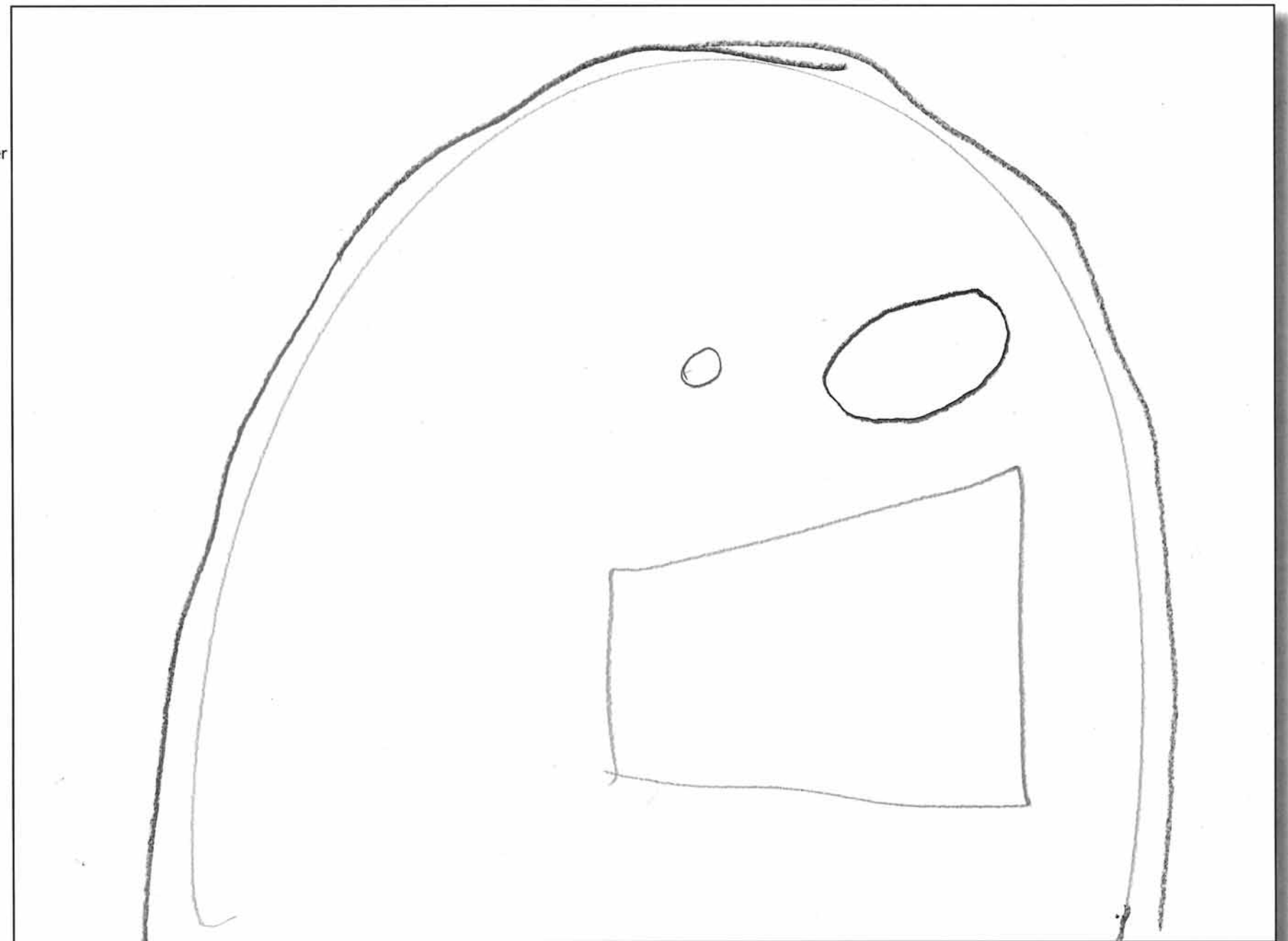

\*Please use the space provided above to sketch any ideas for features you want included in the park and/or to provide further comments.

# NORTH BAY ALL WHEEL PARK

## WORKSHOP FEEDBACK FORM

16

Name: [redacted] Age: 40

Email: [redacted]

1. What is your primary interest in this project?

- I'm a skateboarder  I'm a BMX rider  I'm a roller skater / blader  I'm a scooter rider  
 I'm a parent / guardian or spectator  Other (please specify) \_\_\_\_\_

2. How would you describe your skateboarding / riding ability?

- Beginner  Intermediate  Advanced  I don't skate or ride

3. How often do you skate / ride?

- 3+ days a week  1-2 times a week  1-2 times a month  I don't skate or ride

4. What part of the All Wheel Park interests you the most?

- Pump Track  Skatepark

5. What is your preferred style of Pump Track Terrain?

- Single Track  Double Track  Other (please specify) head to head track.

6. What is your preferred style of Skatepark Terrain?

- Technical Street Terrain  Flowing Street Terrain  
 In-Ground Enclosed Bowls  Mini Ramp / Open Flow  
 Other (please specify) spine

7. Beyond the Skatepark & Pump Track facilities themselves, is there anything else you would like to see in the park? (i.e. seating / viewing spaces, landscaping, shade, washrooms, etc.)

\_\_\_\_\_  
\_\_\_\_\_  
\_\_\_\_\_

8. General Comments. (use the adjacent box or back of this sheet if you need more space)

\_\_\_\_\_  
\_\_\_\_\_  
\_\_\_\_\_

RFP looks good 720sqm<sup>2</sup> skate park  
2500sqm<sup>2</sup> pump track

-if we can get velosolution head to head track would be ideal

pump track

pavilion

Skate park

B-ball

\*Please use the space provided above to sketch any ideas for features you want included in the park and/or to provide further comments.



NORTH BAY, ON

September 21, 2023

WWW.NEWLINESKATEPARKS.COM

# NORTH BAY ALL WHEEL PARK

17

## WORKSHOP FEEDBACK FORM

Name: [REDACTED]

Age: 40

Email: [REDACTED]

1. What is your primary interest in this project?

- I'm a skateboarder    I'm a BMX rider    I'm a roller skater / blader    I'm a scooter rider  
 I'm a parent / guardian or spectator    Other (please specify) Mountain Biker

2. How would you describe your skateboarding / riding ability?

- Beginner    Intermediate    Advanced    I don't skate or ride

3. How often do you skate / ride?

- 3+ days a week    1-2 times a week    1-2 times a month    I don't skate or ride

4. What part of the All Wheel Park interests you the most?

- Pump Track    Skatepark

5. What is your preferred style of Pump Track Terrain?

- Single Track    Double Track    Other (please specify) \_\_\_\_\_

6. What is your preferred style of Skatepark Terrain?

- Technical Street Terrain    Flowing Street Terrain  
 In-Ground Enclosed Bowls    Mini Ramp / Open Flow  
 Other (please specify) \_\_\_\_\_

7. Beyond the Skatepark & Pump Track facilities themselves, is there anything else you would like to see in the park? (i.e. seating / viewing spaces, landscaping, shade, washrooms, etc.)

\_\_\_\_\_  
\_\_\_\_\_  
\_\_\_\_\_

8. General Comments. (use the adjacent box or back of this sheet if you need more space)

I will forward survey to members of  
our local Mountain Bike Association.

\*Please use the space provided above to sketch any ideas for features you want included in the park and/or to provide further comments.



NORTH BAY, ON

September 21, 2023

WWW.NEWLINESSKATEPARKS.COM

# NORTH BAY ALL WHEEL PARK

18

## WORKSHOP FEEDBACK FORM

Name: [REDACTED] Age: 61

Email: [REDACTED]

1. What is your primary interest in this project?

- I'm a skateboarder    I'm a BMX rider    I'm a roller skater / blader    I'm a scooter rider  
 I'm a parent / guardian or spectator    Other (please specify) pump track

2. How would you describe your skateboarding / riding ability?

- Beginner    Intermediate    Advanced    I don't skate or ride

3. How often do you skate / ride?

- 3+ days a week    1-2 times a week    1-2 times a month    I don't skate or ride

4. What part of the All Wheel Park interests you the most?

- Pump Track    Skatepark

5. What is your preferred style of Pump Track Terrain?

- Single Track    Double Track    Other (please specify) or multi-route free flow

6. What is your preferred style of Skatepark Terrain?

- Technical Street Terrain    Flowing Street Terrain  
 In-Ground Enclosed Bowls    Mini Ramp / Open Flow  
 Other (please specify) \_\_\_\_\_

7. Beyond the Skatepark & Pump Track facilities themselves, is there anything else you would like to see in the park? (i.e. seating / viewing spaces, landscaping, shade, washrooms, etc.)

Solar panels on the plaza  
structure to power all lighting  
components

8. General Comments. (use the adjacent box or back of this sheet if you need more space)

An opportunity for a commercial  
concession structure would be  
really beneficial, could provide  
rentals, accessories, lessons, events.

\*Please use the space provided above to sketch any ideas for features you want included in the park and/or to provide further comments.



NORTH BAY, ON

September 21, 2023

WWW.NEWLINESKATEPARKS.COM

# NORTH BAY ALL WHEEL PARK

## WORKSHOP FEEDBACK FORM

19

Name: [Redacted]

Age: 18

Email: [Redacted]

1. What is your primary interest in this project?

- I'm a skateboarder     I'm a BMX rider     I'm a roller skater / blader     I'm a scooter rider  
 I'm a parent / guardian or spectator     Other (please specify) \_\_\_\_\_

2. How would you describe your skateboarding / riding ability?

- Beginner     Intermediate     Advanced     I don't skate or ride

3. How often do you skate / ride?

- 3+ days a week     1-2 times a week     1-2 times a month     I don't skate or ride

4. What part of the All Wheel Park interests you the most?

- Pump Track     Skatepark

5. What is your preferred style of Pump Track Terrain?

- Single Track     Double Track     Other (please specify) \_\_\_\_\_

6. What is your preferred style of Skatepark Terrain?

- Technical Street Terrain     Flowing Street Terrain  
 In-Ground Enclosed Bowls     Mini Ramp / Open Flow  
 Other (please specify) \_\_\_\_\_

7. Beyond the Skatepark & Pump Track facilities themselves, is there anything else you would like to see in the park? (i.e. seating / viewing spaces, landscaping, shade, washrooms, etc.)

A place to sit down in the shade is always welcomed... for possibly a place to enjoy the lake view while skating would be amazing.  
possibly set interact with a local artist.

8. General Comments. (use the adjacent box or back of this sheet if you need more space)

I would love some art integrated into this park. Such as a mural, or native american culture integration and possibly some references to the city (shut flies, etc).  
Maybe include some crew and ojibway language into the park. I'd love to encourage public music such as a spot for public performances.

\*Please use the space provided above to sketch any ideas for features you want included in the park and/or to provide further comments.



NORTH BAY, ON

September 21, 2023

WWW.NEWLINESKATEPARKS.COM



# NORTH BAY ALL WHEEL PARK

## WORKSHOP FEEDBACK FORM

20

Name: [REDACTED] Age: 30

Email: [REDACTED]

1. What is your primary interest in this project?

- I'm a skateboarder  I'm a BMX rider  I'm a roller skater / blader  I'm a scooter rider  
 I'm a parent / guardian or spectator  Other (please specify) **OBSTACLE + RAMP DESIGNER**

2. How would you describe your skateboarding / riding ability?

- Beginner  Intermediate  Advanced  I don't skate or ride

3. How often do you skate / ride?

- 3+ days a week  1-2 times a week  1-2 times a month  I don't skate or ride

4. What part of the All Wheel Park interests you the most?

- Pump Track  Skatepark

5. What is your preferred style of Pump Track Terrain?

- Single Track  Double Track  Other (please specify) **concrete**

6. What is your preferred style of Skatepark Terrain?

- Technical Street Terrain  Flowing Street Terrain  
 In-Ground Enclosed Bowls  Mini Ramp / Open Flow  
 Other (please specify) **I love it all**

7. Beyond the Skatepark & Pump Track facilities themselves, is there anything else you would like to see in the park? (i.e. seating / viewing spaces, landscaping, shade, washrooms, etc.)

**24 hr motion lights. lighting. good lighting. focus on flow + space**  
**Rain cover?**

8. General Comments. (use the adjacent box or back of this sheet if you need more space)

**Thank you.**

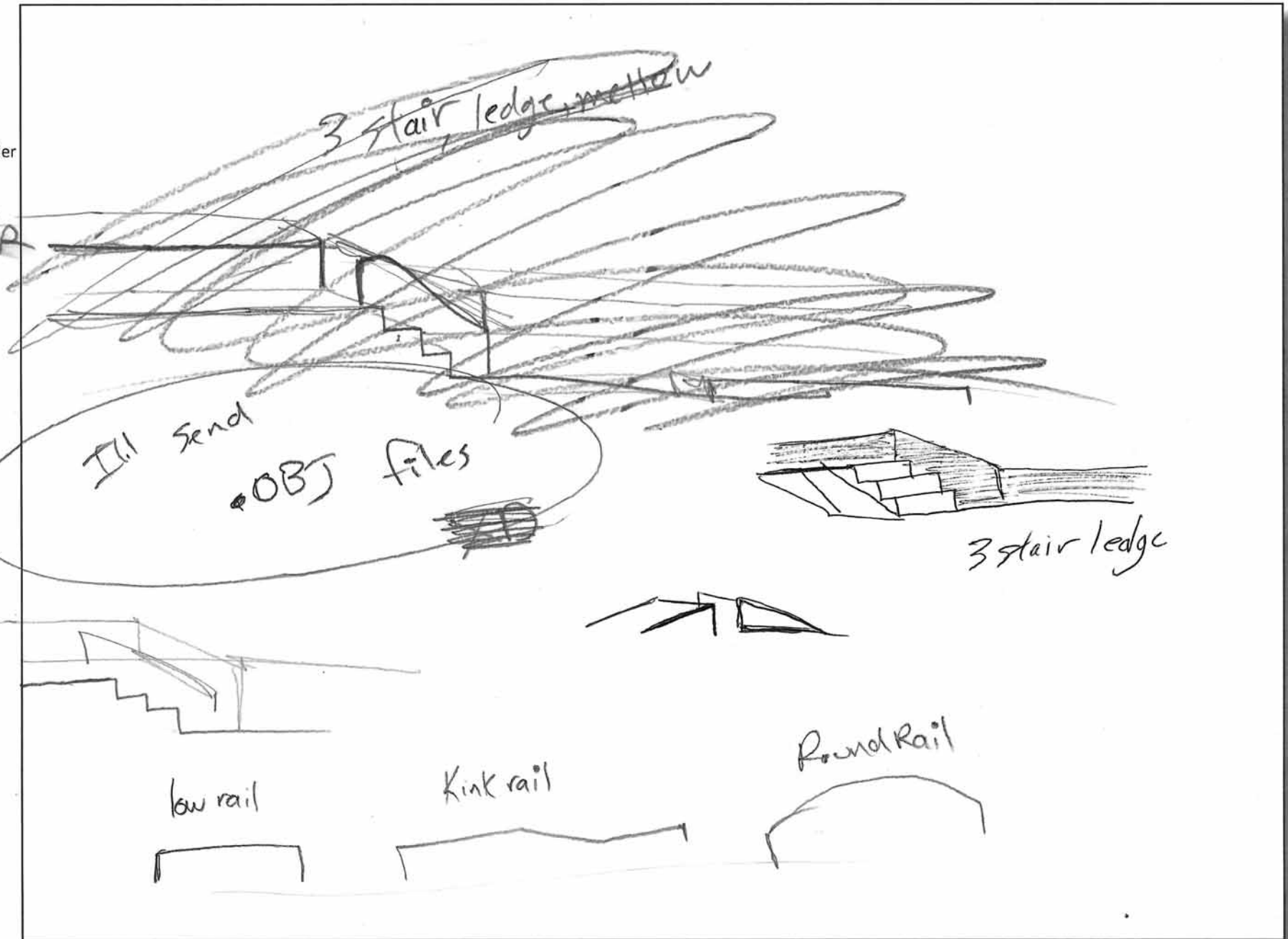

\*Please use the space provided above to sketch any ideas for features you want included in the park and/or to provide further comments.

# NORTH BAY ALL WHEEL PARK

## WORKSHOP FEEDBACK FORM

21

Name: [REDACTED] Age: 33

Email: [REDACTED]

1. What is your primary interest in this project?

- I'm a skateboarder    I'm a BMX rider    I'm a roller skater / blader    I'm a scooter rider  
 I'm a parent / guardian or spectator    Other (please specify) \_\_\_\_\_

2. How would you describe your skateboarding / riding ability?

- Beginner    Intermediate    Advanced    I don't skate or ride

3. How often do you skate / ride?

- 3+ days a week    1-2 times a week    1-2 times a month    I don't skate or ride

4. What part of the All Wheel Park interests you the most?

- Pump Track    Skatepark

5. What is your preferred style of Pump Track Terrain?

- Single Track    Double Track    Other (please specify) Concrete

6. What is your preferred style of Skatepark Terrain?

- Technical Street Terrain    Flowing Street Terrain  
 In-Ground Enclosed Bowls    Mini Ramp / Open Flow  
 Other (please specify) \_\_\_\_\_

7. Beyond the Skatepark & Pump Track facilities themselves, is there anything else you would like to see in the park? (i.e. seating / viewing spaces, landscaping, shade, washrooms, etc.)

Water access, shaded area, high step up, 3 stair.  
Possibly lights for nights in spring and fall.  
in a big fan of the coloured concrete.

8. General Comments. (use the adjacent box or back of this sheet if you need more space)

Super pumped to be part of this project, Thrilled  
with the level of care from the project directors  
and the community.

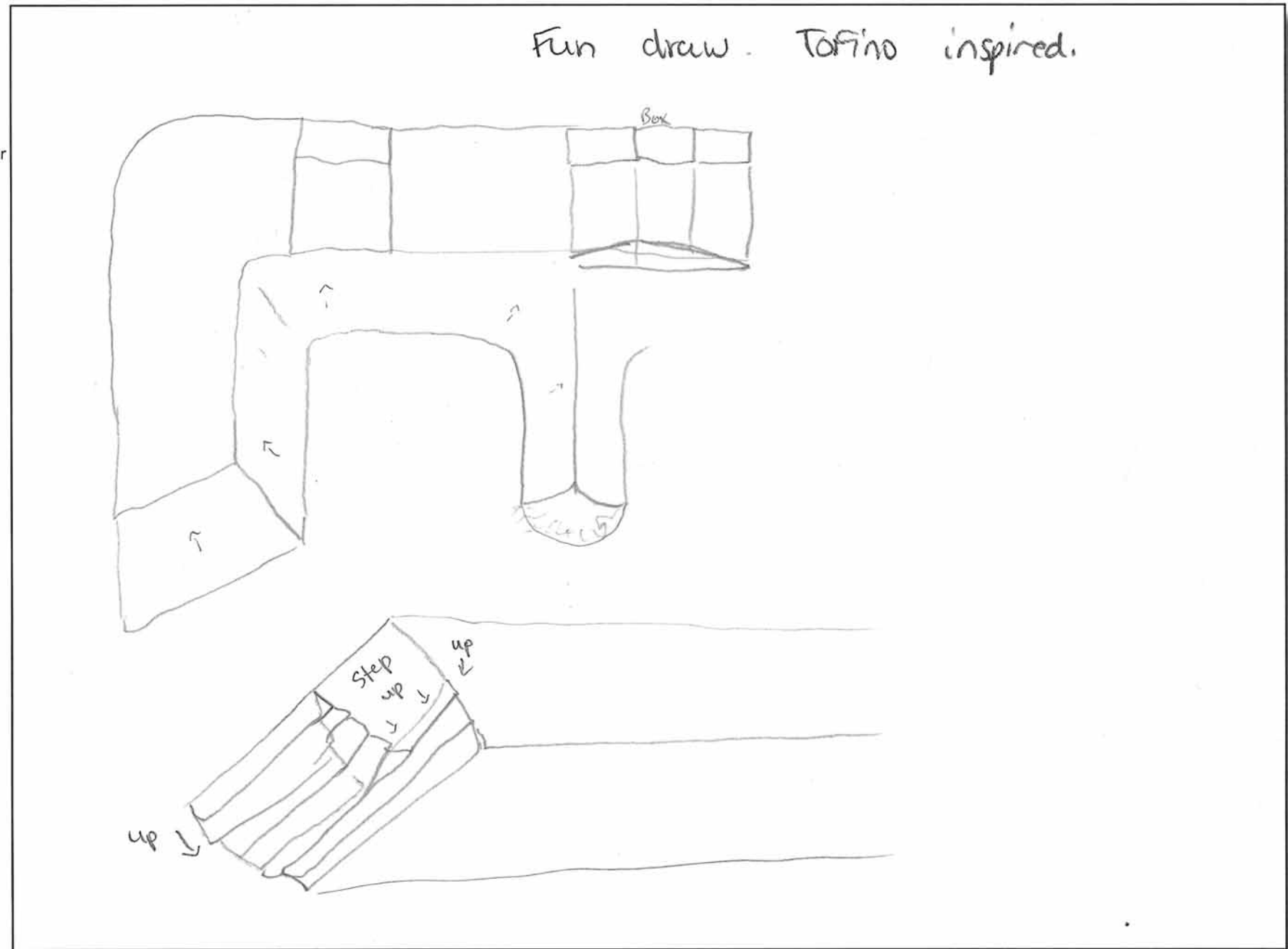

\*Please use the space provided above to sketch any ideas for features you want included in the park and/or to provide further comments.

# NORTH BAY ALL WHEEL PARK

## WORKSHOP FEEDBACK FORM

22

Name: [REDACTED] Age: 47

Email: [REDACTED]

1. What is your primary interest in this project?

- I'm a skateboarder    I'm a BMX rider    I'm a roller skater / blader    I'm a scooter rider  
 I'm a parent / guardian or spectator    Other (please specify) \_\_\_\_\_

2. How would you describe your skateboarding / riding ability?

- Beginner    Intermediate    Advanced    I don't skate or ride

3. How often do you skate / ride?

- 3+ days a week    1-2 times a week    1-2 times a month    I don't skate or ride

4. What part of the All Wheel Park interests you the most?

- Pump Track    Skatepark

5. What is your preferred style of Pump Track Terrain?

- Single Track    Double Track    Other (please specify) \_\_\_\_\_

6. What is your preferred style of Skatepark Terrain?

- Technical Street Terrain    Flowing Street Terrain  
 In-Ground Enclosed Bowls    Mini Ramp / Open Flow  
 Other (please specify) \_\_\_\_\_

7. Beyond the Skatepark & Pump Track facilities themselves, is there anything else you would like to see in the park? (i.e. seating / viewing spaces, landscaping, shade, washrooms, etc.)

\_\_\_\_\_  
\_\_\_\_\_  
\_\_\_\_\_

8. General Comments. (use the adjacent box or back of this sheet if you need more space)

\_\_\_\_\_  
\_\_\_\_\_  
\_\_\_\_\_

[Large empty box for sketching ideas or providing further comments]

\*Please use the space provided above to sketch any ideas for features you want included in the park and/or to provide further comments.



NORTH BAY, ON

September 21, 2023

WWW.NEWLINESKATEPARKS.COM

# NORTH BAY ALL WHEEL PARK

## WORKSHOP FEEDBACK FORM

23

Name: [REDACTED] Age: 19

Email: [REDACTED]

1. What is your primary interest in this project?

- I'm a skateboarder    I'm a BMX rider    I'm a roller skater / blader    I'm a scooter rider  
 I'm a parent / guardian or spectator    Other (please specify) \_\_\_\_\_

2. How would you describe your skateboarding / riding ability?

- Beginner    Intermediate    Advanced    I don't skate or ride

3. How often do you skate / ride?

- 3+ days a week    1-2 times a week    1-2 times a month    I don't skate or ride

4. What part of the All Wheel Park interests you the most?

- Pump Track    Skatepark

5. What is your preferred style of Pump Track Terrain?

- Single Track    Double Track    Other (please specify) \_\_\_\_\_

6. What is your preferred style of Skatepark Terrain?

- Technical Street Terrain    Flowing Street Terrain  
 In-Ground Enclosed Bowls    Mini Ramp / Open Flow  
 Other (please specify) \_\_\_\_\_

7. Beyond the Skatepark & Pump Track facilities themselves, is there anything else you would like to see in the park? (i.e. seating / viewing spaces, landscaping, shade, washrooms, etc.)

would definitely love to see some shade  
on some of the park as well as a water fountain  
and lights for when it's dark

8. General Comments. (use the adjacent box or back of this sheet if you need more space)

\_\_\_\_\_  
\_\_\_\_\_  
\_\_\_\_\_

[Large empty box for sketching ideas or providing further comments]

\*Please use the space provided above to sketch any ideas for features you want included in the park and/or to provide further comments.



NORTH BAY, ON

September 21, 2023

WWW.NEWLINESKATEPARKS.COM

# NORTH BAY ALL WHEEL PARK

## WORKSHOP FEEDBACK FORM

24

Name: [REDACTED]

Age: 46

Email: [REDACTED]

1. What is your primary interest in this project?

- I'm a skateboarder    I'm a BMX rider    I'm a roller skater / blader    I'm a scooter rider  
 I'm a parent / guardian or spectator    Other (please specify) MTBER

2. How would you describe your skateboarding / riding ability?

- Beginner    Intermediate    Advanced    I don't skate or ride

3. How often do you skate / ride?

- 3+ days a week    1-2 times a week    1-2 times a month    I don't skate or ride

4. What part of the All Wheel Park interests you the most?

- Pump Track    Skatepark

5. What is your preferred style of Pump Track Terrain?

- Single Track    Double Track    Other (please specify) \_\_\_\_\_

6. What is your preferred style of Skatepark Terrain?

- Technical Street Terrain    Flowing Street Terrain  
 In-Ground Enclosed Bowls    Mini Ramp / Open Flow  
 Other (please specify) \_\_\_\_\_

7. Beyond the Skatepark & Pump Track facilities themselves, is there anything else you would like to see in the park? (i.e. seating / viewing spaces, landscaping, shade, washrooms, etc.)

VIEWING AND A PROGRESSIVE JUMP LINE DOWN THE AREAS TERRAIN TO HELP WITH THE SKILLS ON A MTB FOR USE IN OTHER LOCAL AREAS.

8. General Comments. (use the adjacent box or back of this sheet if you need more space)

MAYBE A TUNNEL FEATURE HIGHLIGHTING THE MORAD TUNNEL IN TOWN! MAYBE AESTHETIC POINTS OR COLOURS TO DRAW PARALLELS TO OUR TWO BIG LAKES.



\*Please use the space provided above to sketch any ideas for features you want included in the park and/or to provide further comments.

# NORTH BAY ALL WHEEL PARK

## WORKSHOP FEEDBACK FORM

25

Name: [REDACTED] Age: 32

Email: [REDACTED]

1. What is your primary interest in this project?

- I'm a skateboarder    I'm a BMX rider    I'm a roller skater / blader    I'm a scooter rider  
 I'm a parent / guardian or spectator    Other (please specify) \_\_\_\_\_

2. How would you describe your skateboarding / riding ability?

- Beginner    Intermediate    Advanced    I don't skate or ride

3. How often do you skate / ride?

- 3+ days a week    1-2 times a week    1-2 times a month    I don't skate or ride

4. What part of the All Wheel Park interests you the most?

- Pump Track    Skatepark

5. What is your preferred style of Pump Track Terrain?

- Single Track    Double Track    Other (please specify) \_\_\_\_\_

6. What is your preferred style of Skatepark Terrain?

- Technical Street Terrain    Flowing Street Terrain  
 In-Ground Enclosed Bowls    Mini Ramp / Open Flow  
 Other (please specify) \_\_\_\_\_

7. Beyond the Skatepark & Pump Track facilities themselves, is there anything else you would like to see in the park? (i.e. seating / viewing spaces, landscaping, shade, washrooms, etc.)

WASHROOMS, WATER FOUNTAIN FOR HYDRATION-  
LIGHTS

8. General Comments. (use the adjacent box or back of this sheet if you need more space)

NO ASPHALT!

\*Please use the space provided above to sketch any ideas for features you want included in the park and/or to provide further comments.



NORTH BAY, ON

September 21, 2023

WWW.NEWLINESKATEPARKS.COM

# NORTH BAY ALL WHEEL PARK

## WORKSHOP FEEDBACK FORM

26

Name:

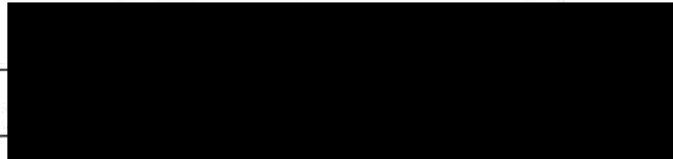

Age: 33

Email:

1. What is your primary interest in this project?

- I'm a skateboarder    I'm a BMX rider    I'm a roller skater / blader    I'm a scooter rider  
 I'm a parent / guardian or spectator    Other (please specify) \_\_\_\_\_

2. How would you describe your skateboarding / riding ability?

- Beginner    Intermediate    Advanced    I don't skate or ride

3. How often do you skate / ride?

- 3+ days a week    1-2 times a week    1-2 times a month    I don't skate or ride

4. What part of the All Wheel Park interests you the most?

- Pump Track    Skatepark

5. What is your preferred style of Pump Track Terrain?

- Single Track    Double Track    Other (please specify) \_\_\_\_\_

6. What is your preferred style of Skatepark Terrain?

- Technical Street Terrain    Flowing Street Terrain  
 In-Ground Enclosed Bowls    Mini Ramp / Open Flow  
 Other (please specify) \_\_\_\_\_

7. Beyond the Skatepark & Pump Track facilities themselves, is there anything else you would like to see in the park? (i.e. seating / viewing spaces, landscaping, shade, washrooms, etc.)

Water fountains, Washrooms, Emergency Service  
Washrooms  
Spot Lighting for Night skating, Lake View

8. General Comments. (use the adjacent box or back of this sheet if you need more space)

\_\_\_\_\_  
\_\_\_\_\_  
\_\_\_\_\_

\*Please use the space provided above to sketch any ideas for features you want included in the park and/or to provide further comments.



NORTH BAY, ON

September 21, 2023

WWW.NEWLINESKATEPARKS.COM